

ND30

-METER OF POWER NETWORK PARAMETERS



- **Measurement and recording** of 54 power network parameters, including **current and voltage harmonics up to 51st**, in 1-phase 2-wire or 3-phase 3 or 4-wire balanced and unbalanced systems.
- **graphical color display**: ICD TFT 3,5", 320 x 240 pixels, **fully configurable by a user** (10 views, 8 parameters in each)
- indications include the values of programmed ratios.
- Memory of minimum and maximum values.
- 2 configurable alarm outputs.
- Optional: analog output 0/4...20 mA and 2 PT 100 inputs (eg. for measurement of transformer temperature).
- Data archiving in the internal memory 8GB (option).
- Digital output RS-485 - MODBUS protocol.
- **Modern and user-friendly Ethernet interface** 10/100 BASE-T (option):
 - protocol: MODBUS TCP/IP, HTTP, FTP,
 - services: www server, ftp server, DHCP client.
- Programming of parameters using **free econ software**.
- Battery backup RTC.
- Overall dimensions: 96x96x77 mm.

EXAMPLE OF APPLICATION

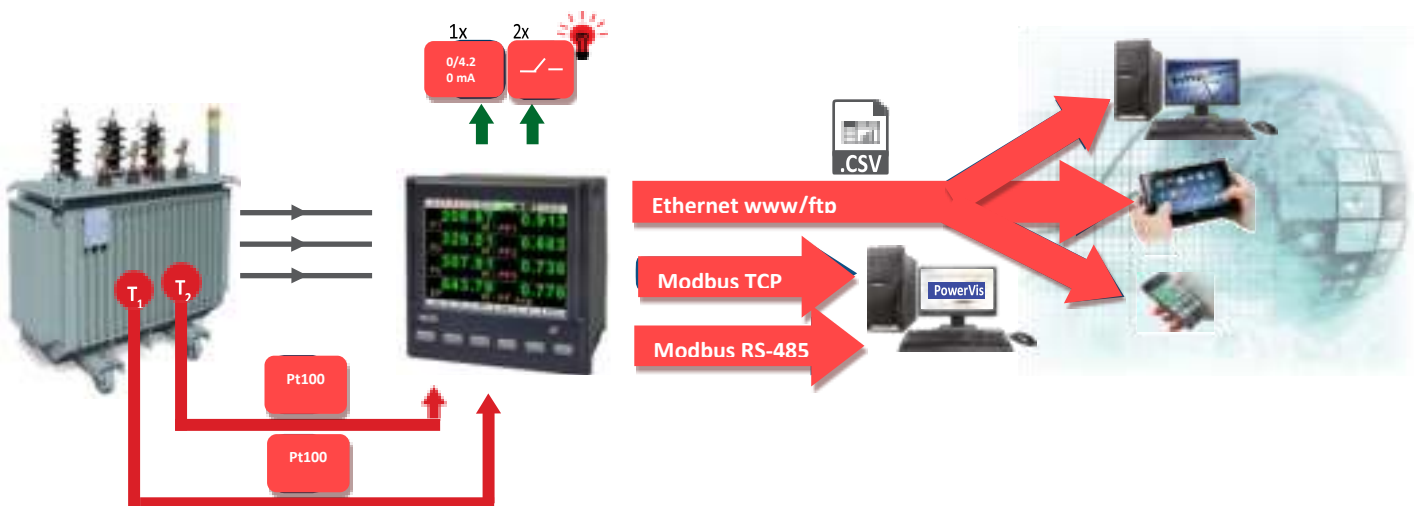

MEASUREMENT AND VISUALIZATION OF POWER NETWORK PARAMETERS

- phase voltages: U_1, U_2, U_3
- phase-to-phase voltages: U_{12}, U_{23}, U_{31}
- phase currents i_1, i_2, i_3
- active phase powers: P_1, P_2, P_3
- reactive phase powers: Q_1, Q_2, Q_3
- apparent phase powers: S_1, S_2, S_3
- active power factors: PF_1, PF_2, PF_3
- reactive/active power factors: $tg\alpha_1, tg\alpha_2, tg\alpha_3$
- active, reactive and apparent 3-phase power: P, Q, S
- mean 3-phase power factors: $PF, tg\alpha$
- frequency f
- mean 3-phase voltage: U_s
- mean phase-to-phase voltage: U_{mf}
- mean 3-phase current: i_s
- 15, 30, 60 minutes' mean active power: P_{demand}
- mean apparent power S_{demand}
- average current i_{demand}
- active, reactive and apparent 3-phase energy: EnP, EnQ, EnS
- active, reactive and apparent energy from external counter: $EnPE$
- total harmonic content coefficients for phase voltages and currents $THD_{U1}, THD_{U2}, THD_{U3}, THD_{I1}, THD_{I2}, THD_{I3}$ and for 3-phase voltages and currents THD_U, THD_I
- harmonics for current and phase voltage up to 51 st!
- temperature (2 x Pt100 input)

ND30 - METER OF POWER NETWORK PARAMETERS

FEATURES	INPUTS	OUTPUTS	GALVANIC ISOLATION

TECHNICAL DATA

MEASURING RANGE

Measured value	Measuring range	I1	I2	I3	Σ	class (*) / Basic error (*) class relative to the measured value acc. to en61557-12
Current I/5A 1 A~ 5 A~	0.010 ..0.100..1.200 A (tr_i=1) 0.050 ..0.500..6.000 A (tr_i=1) ...20.00 kA (tr_i≠1)	•	•	•		Class 0.2
Voltage I-N 57.7 V~ 230 V~ 400 V~	5.7..11.5 ..70.0 V (tr_U=1) 23.0..46 ..276.0 V (tr_U=1) 40.0..80 ..480.0 V (tr_U=1) ...480.0 kV (tr_U≠1)	•	•	•		Class 0.2
Voltage I-I 100 V~ 400 V~ 690 V~	10.0 ..20..120.0 V (tr_U=1) 40.0..80 ..480.0 V (tr_U=1) 69.0..138 ..830.0 V (tr_U=1) ...830.0 kV (tr_U≠1)	•	•	•		Class 0.5
Active power P _i , average active power P _{dt}	.. (-)1999.9 W ..(-)1999.9 MW (tr_U≠1.tr_i≠1)	•	•	•	•	Class 0.5
Reactive power Q _i	.. (-)1999.9 Var ..(-)1999.9 MVar (tr_U≠1.tr_i≠1)	•	•	•	•	Class 1
Apparent power S _i , average apparent power S _{dt}	..1999.9 VA ..1999.9 MVA (tr_U≠1.tr_i≠1)	•	•	•	•	Class 0.5
Active energy EnP (imported or exported)	.. (-)1999.9 Wh ..(-)1999.9 MWh (tr_U≠1.tr_i≠1)				•	Class 0.5
Reactive energy EnQ (inductive or capacitive)	.. (-)1999.9 Varh ..(-)1999.9 MVarh (tr_U≠1.tr_i≠1)				•	Class 1
Apparent energy EnS	..1999.9 VAh ..1999.9 MVAh (tr_U≠1.tr_i≠1)				•	Class 0.5
Active power factor PF _i	-1.00 ..0 ..1.00	•	•	•	•	± 0.01 of basic error
Coefficient tgφ _i (ratio of reactive power to active power)	-1.20 ..0 ..1.20	•	•	•	•	± 0.01 of basic error
Frequency f	45.00..65.00 Hz				•	Class 0.1
Total harmonic distortion of voltage THDU and current THDi	0.0 ..100.0 %	•	•	•	•	Class 5 50 / 60 Hz
Amplitudes of the voltage U _{h1} ... U _{h50} , and current I _{h1} ... I _{h50}	0.0 ..100.0 %	•	•	•		Class 5 50 / 60 Hz

tr_i, tr_U – ratio of current and voltage transformer

INPUTS

input type	properties
input Pt100 (T1, T2) - option	2 x Pt100, 2-wire, -50...400°C, basic error 0.5 %

DIGITAL INTERFACE

interface type	transmission protocol	remarks
RS-485	Modbus RTU 8N2,8E1,8O1,8N1 Address 1..247	baud rate: 4.8, 9.6, 19.2 38.4, 57.6, 115.2 kbit/s
Ethernet 10/100 Base-T -option	Modbus TCP,HTTP,FTP	WWW server, FTP server, DHCP client

ND30 - METER OF POWER NETWORK PARAMETERS

EXTERNAL FEATURES

readout field	graphic color display ICD TFT 3,5", 320 x 240 pixels	
overall dimensions	96 x 96 x 77 mm	mounting hole 92.5 x 92.5 mm
Weight	0.3 kg	
protection grade	from frontal side: iP65	from terminal side: iP20

RATED OPERATING CONDITIONS

supply voltage	85...253V a.c. (40...50...400Hz), 90...300V d.c. or 20...40V a.c., 20...60V d.c.	power consumption \leq 6 VA
power consumption	in voltage circuit \leq 0.2 VA	in current circuit \leq 0.1 VA
input signal	0...0.1...1.2 in; 0.1...0.2...1.2 Un for current, voltage, PF, tg ϕ	frequency 45...50...60...65 Hz, sinusoidal (THD \leq 8%)
power factor	-1...0...1	
preheating time	5 min.	
ambient temperature	-10...23...55°C, class k55 acc. to EN61557-12	
Humidity	0...40...65...95%	without condensation
operating position	any	
external magnetic field	\leq 40...400 A/m d.c.	\leq 3 A/m a.c. 50/60 Hz
short-term overload	voltage input: 2 Un (5 sec.)	current input 50 A (1 sec.)
admissible crest factor	current: 2	voltage: 2
additional error (in % of the intrinsic error)		from ambient temperature change: $<$ 50% / 10°C

SAFETY AND COMPATIBILITY REQUIREMENTS

electromagnetic compatibility	noise immunity	acc. to EN 61000-6-2
	noise emissions	acc. to EN 61000-6-4
isolation insured by the casing	double	acc. to EN 61010-1
isolation between circuits	basic	acc. to EN 61010-1
pollution level	2	acc. to EN 61010-1
installation category	iii	acc. to EN 61010-1
Maximal phase-to-earth voltage	<ul style="list-style-type: none"> for supply circuit and relay outputs 300 V for measuring input 500 V for circuits of RS-485, Ethernet, pulse input and output, analog outputs: 50 V 	acc. to EN 61010-1
altitude a.s.l.	$<$ 2000 m	

CONNECTION DIAGRAMS

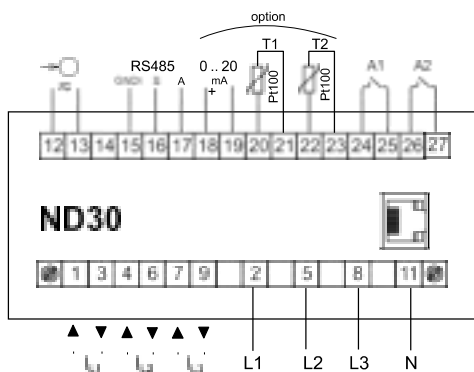

Description of meter connections strips

Ethernet (option)

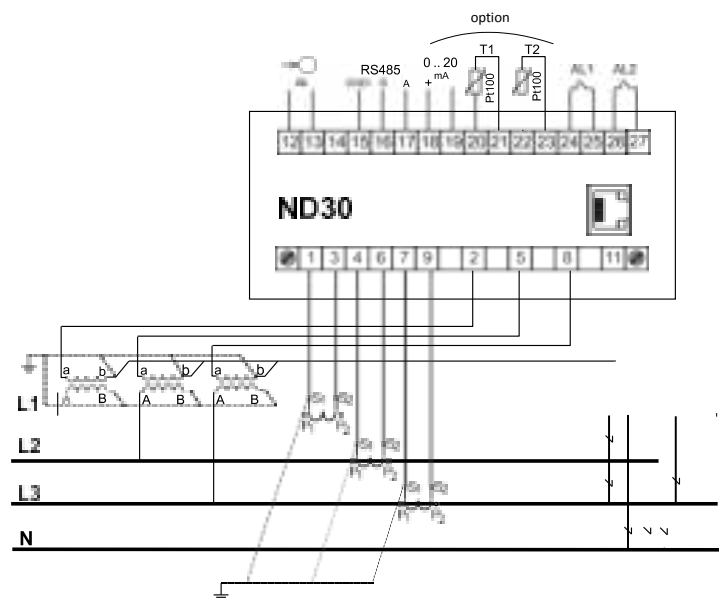

indirect measurement in 4-wire network - connection of input signals

DISPLACING OF MEASUREMENT PARAMETERS



up to 10 programmable screens
(8 parameters per page);
ability to change color for all screens

Available colors for digital indications:

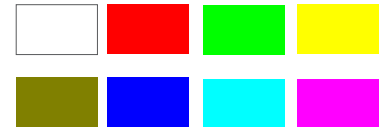

two screens dedicated to harmonics;
indication of individual harmonic
for voltages and currents (up to 51st);
bargraph presentation for all harmonics
with zoom function



easy to use and intuitive menu;
information bar with status of: phase
sequence, alarm outputs, temperature
measurements*, archiving and memory*,
Ethernet* and RS-485 interfaces,
time and date

*- availability of feature depends on
hardware version of ND30

ND30 - METER OF POWER NETWORK PARAMETERS

METER CONFIGURATION WITH FREE eCON SOFTWARE

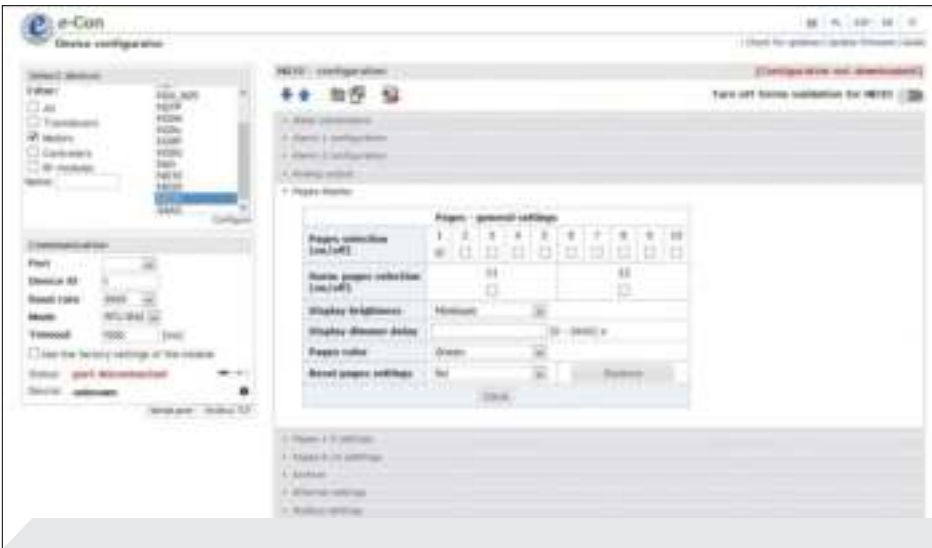

ability to configure and update ND30 with free eCon software (via RS-485 or Ethernet* interface)

*- availability of feature depends on hardware version of ND30

REMOTE READOUT OF PARAMETERS THROUGH ETHERNET: WWW SERVER, FTP



WEB server* for remote reading of current measurement data; FTP server* for downloading archived CSV files

*- availability of feature depends on hardware version of ND30



ND30 - METER OF POWER NETWORK PARAMETERS

ORDERING CODE

Meter ND30 -	X	X	X	X	XX	X	X
input voltage (phase/phase-to-phase) un:							
3 x 57.7/ 100 V, 3x 230/ 400 V	1						
3 x 110/ 190 V, 3 x 400/ 690 V	2						
additional outputs /inputs:							
2 relays	1						
2 relays, 1 analog output, 2 inputs PT100	2						
interface:							
RS-485		1					
RS-485 and Ethernet, internal memory		2					
supply:							
85...253 V a.c., 90...300 V d.c.			1				
20...40 V a.c., 20...60 V d.c.			2				
version:							
standard				00			
custom-made*				XX			
language:							
Polish						P	
English						E	
other*						X	
acceptance tests:							
without additional quality requirements							0
with an extra quality inspection certificate							1
acc.to customer's request*							X

order example:

The code: **nD30 - 1 2 2 1 00 e 0** means:

nD30 - meter ND30

1 - input voltage 3 x 57.7/ 100 V, 3x 230/ 400 V

2 - 2 relays, 1 analog output, 2 inputs PT100

2 - RS-485 and Ethernet, internal memory

1 - supply: 85...253 V a.c., 90...300 V d.c.

00 - standard version

e - user's manual in English

0 - without additional quality requirements.

* only after agreeing with the manufacturer

SEE ALSO:



ND40 - power network analyzer/



RE92 - dual loop



P30U - universal transducer of temperature and standard signals



KS31 - Digital synchronizing unit



N43 - rail mounted 3-phase power network



P43 - 3-phase transducer of power network parameters



ND1 - analyser of network parameters



Current transformers from 5 A up to 6 kA



Free **eCON** software

For more information about ST products please visit our website:

www.sifamtinsley.com

Join us at Facebook!





Multifunction Meters

Transducers & Isolators

Temperature Controllers

Converters & Recorders

Digital Panel Meters

Current Transformers

Analogue Panel Meters

Shunts

Digital Multimeters

Clamp Meters

Insulation Testers

ND30PNET

METER OF POWER NETWORK PARAMETERS WITH **PROFINET**

Features

- Measurement of 54 power network parameters, including current and voltage harmonics up to 51st, in 1-phase 2-wire or 3-phase 3 or 4-wire balanced and unbalanced systems.
- Graphical color display: ICd TFT 3,5", 320 x 240 pixels, fully configurable by a user (10 vies, 8 parameters in each).
- Indications include the values of programmed ratios.
- Memory of minimum and maximum values.
- 2 configurable alarm outputs.
- Optional: analog output 0/4...20 mA and 2 PT 100 inputs (eg. for measurement of transformer temperature).
- Digital output RS-485 - MODBUS protocol.
- Modern and user-friendly ethernet/profi net (version 2.2.) interface.
- Programming of parameters using free econ software.
- Battery backup RTC.
- Overall dimensions: 96 x 96 x 77 mm.

Example of Application

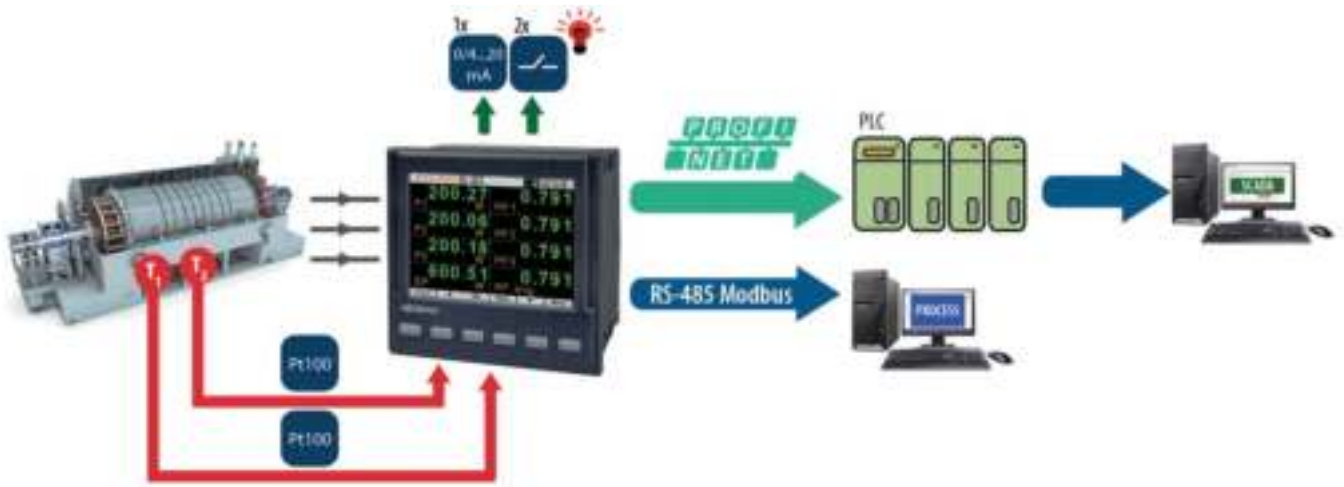

Measurement and Visualization of Power Network Parameters

- Phase voltages: U_1, U_2, U_3
- Phase-to-phase voltages: U_{12}, U_{23}, U_{31}
- Phase currents I_1, I_2, I_3
- Active phase powers: P_1, P_2, P_3
- Reactive phase powers: Q_1, Q_2, Q_3
- Apparent phase powers: S_1, S_2, S_3
- Active power factors: PF_1, PF_2, PF_3
- Reactive/active power factors: $tg\varphi_1, tg\varphi_2, tg\varphi_3$
- Active, reactive and apparent 3-phase power: P, Q, S
- Mean 3-phase power factors: $PF, tg\varphi$
- Frequency f
- Mean 3-phase voltage: U_s
- Mean phase-to-phase voltage: U_{mf}
- Mean 3-phase current: I_s
- 15, 30, 60 minutes' mean active power: P_{demand}
- Mean apparent power S_{demand}
- Average current i_{demand}
- Active, reactive and apparent 3-phase energy: EnP, EnQ, EnS
- Active, reactive and apparent energy from external counter: $EnPE$
- Total harmonic content coefficients for phase voltages and currents $THD_{U1}, THD_{U2}, THD_{U3}, THD_{I1}, THD_{I2}, THD_{I3}$ and for 3-phase voltages and currents THD_U, THD_I
- Harmonics for current and phase voltage up to 51 st!
- Temperature (2 x Pt100 input)

Features



Inputs



Outputs



Galvanic Isolation



Technical Data - Measuring Range

Measured value	Measuring range	L1	L2	L3	Σ	Class (*) / Basic error (*) class relative to the measured value acc. to EN61557-12
Current I/5 A 1 A~ 5 A~	0.010 ..0.100..1.200 A (tr_I=1) 0.050 ..0.500.. 6.000 A (tr_I=1) ...20.00 kA (tr_I≠1)	•	•	•		Class 0.2
Voltage L-N 57.7 V~ 230 V~ 400 V~	5.7..11.5 ..70.0 V (tr_U=1) 23.0..46 .. 276.0 V (tr_U=1) 40.0..80 .. 480.0 V (tr_U=1) ...480.0 kV (tr_U≠1)	•	•	•		Class 0.2
Voltage L-L 100 V~ 100 V~ 400 V~ 690 V~	10.0 ..20..120.0 V (tr_U=1) 40.0..80 .. 480.0 V (tr_U=1) 69.0..138 .. 830.0 V (tr_U=1) ...830.0 kV (tr_U≠1)	•	•	•		Class 0.5
Active power P _i , average active power P _{dt}	.. (-)1999.9 W .. (-)1999.9 MW (tr_U≠1, tr_I≠1)	•	•	•	•	Class 0.5
Reactive power Q _i	.. (-)1999.9 Var .. (-)1999.9 MVar (tr_U≠1, tr_I≠1)	•	•	•	•	Class 1
Apparent power S _i , average apparent power S _{dt}	..1999.9 VA ..1999.9 MVA (tr_U≠1, tr_I≠1)	•	•	•	•	Class 0.5
Active energy EnP (imported or exported)	.. (-)1999.9 Wh .. (-)1999.9 MWh (tr_U≠1, tr_I≠1)				•	Class 0.5
Reactive energy EnQ (inductive or capacitive)	.. (-)1999.9 Varh .. (-)1999.9 MVarh (tr_U≠1, tr_I≠1)				•	Class 1
Apparent energy EnS	.. 1999.9 VAh ..1999.9 MVAh (tr_U≠1, tr_I≠1)				•	Class 0.5
Active power factor PF _i	-1.00 ..0 ..1.00	•	•	•	•	± 0.01 of basic error
Coefficient tgφ _i (ratio of reactive power to active power)	-1.20 ..0 ..1.20	•	•	•	•	± 0.01 of basic error
Frequency f	45.00..65.00 Hz				•	Class 0.1
Total harmonic distortion of voltage THDU and current THDI	0.0 ..100.0 %	•	•	•	•	Class 5 50 / 60 Hz
Amplitudes of the voltage U _{h1} ... U _{h50} , and current I _{h1} ... I _{h50}	0.0 ..100.0 %	•	•	•		Class 5 50 / 60 Hz

tr_I, tr_U – ratio of current and voltage transformer

Inputs

Input type	Properties
Input Pt100 (T1, T2) - option	2 x Pt100, 2-wire, -50...400°C, basic error 0.5 %

Digital Interface

Interface type	Transmission protocol	Baud rate
RS-485	Modbus RTU 8N2,8E1,8O1,8N1 Address 1..247	baud rate: 4.8, 9.6, 19.2 38.4, 57.6, 115.2 kbit/s
Ethernet /Profinet	ICMP (Ping) / Profinet version 2.2	

External Features

Readout field	graphic colour display LCD TFT 3,5" , 320 x 240 pixels	
Overall dimensions	96 x 96 x 77 mm	mounting hole 92.5 x 92.5 mm
Weight	0.3 kg	
Protection grade	from frontal side: IP65	from terminal side: IP20

Rated Operating Conditions

Supply voltage	→ 085...253 V a.c. (40...50...400 Hz) , 90...300 V d.c. or 20...40 V a.c., 20...60 V d.c.	power consumption ≤ 6 VA
Power consumption	in voltage circuit ≤ 0.2 VA	in current circuit ≤ 0.1 VA
Input signal	0...0.1...1.2 In; 0.1...0.2...1.2 Un for current, voltage, PFi, tgji	frequency 45...50...60...65 Hz, sinusoidal (THD ≤ 8%)
Power factor	-1...0...1	
Preheating time	5 min.	
Ambient temperature	-10...23...55°C, class K55 acc. to EN61557-12	
Humidity	0...40...65...95%	without condensation
Operating position	any	
External magnetic field	≤ 40...400 A/m d.c.	≤ 3 A/m a.c. 50/60 Hz
Short-term overload	voltage input: 2 Un (5 sec.)	current input 50 A (1 sec.)
Admissible crest factor	current: 2	voltage: 2
Additional error (in % of the intrinsic error)		from ambient temperature change: < 50% / 10°C

Safety and Compatibility Requirements

Electromagnetic compatibility	noise immunity	acc. to EN 61000-6-2
	noise emissions	acc. to EN 61000-6-4
Isolation insured by the casing	double	acc. to EN 61010-1
Isolation between circuits	basic	acc. to EN 61010-1
Pollution level	2	acc. to EN 61010-1
Installation category	III	acc. to EN 61010-1
Maximal phase-to-earth voltage	<ul style="list-style-type: none"> • for supply circuit and relay outputs 300 V • for measuring input 500 V • for circuits of RS-485, Ethernet, pulse input and output, analogue outputs: 50 V 	acc. to EN 61010-1
Altitude a.s.l.	< 2000 m	

Connection Diagrams

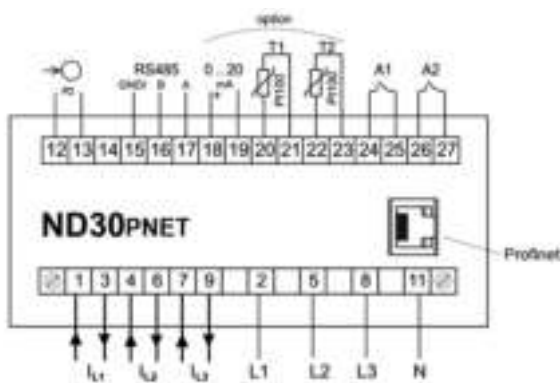

Description of meter connections strips

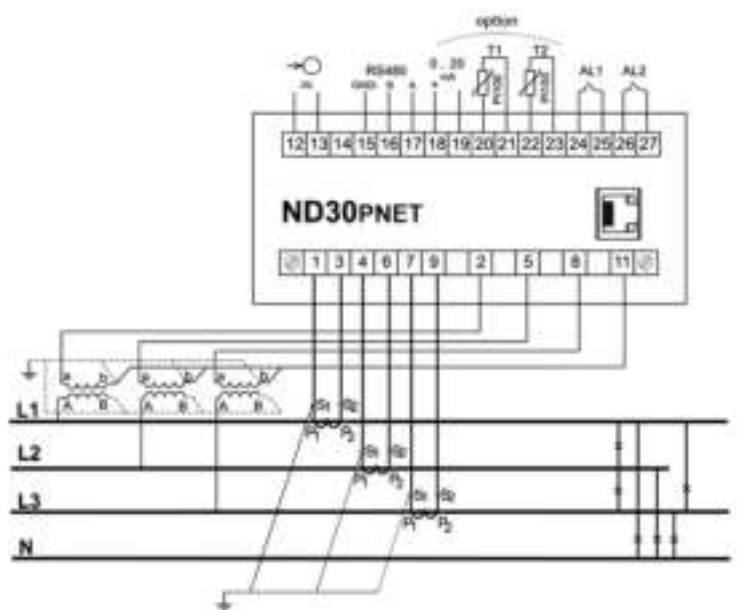

Indirect measurement in 4-wire network - connection of input signals

Displaying of Measurement Parameters



Up to 10 programmable screens (8 parameters per page); ability to change colour for all screens.

Available colours for digital indications:



Two screens dedicated to harmonics; indication of individual harmonic for voltages and currents (up to 51st); bargraph presentation for all harmonics with zoom function.



Easy to use and intuitive menu; information bar with status of: phase sequence, alarm outputs, temperature measurements*, archiving and memory*, Ethernet* and RS-485 interfaces, time and date.

*Availability of feature depends on hardware version of ND30PNET.

Meter Configuration with Free eCon Software

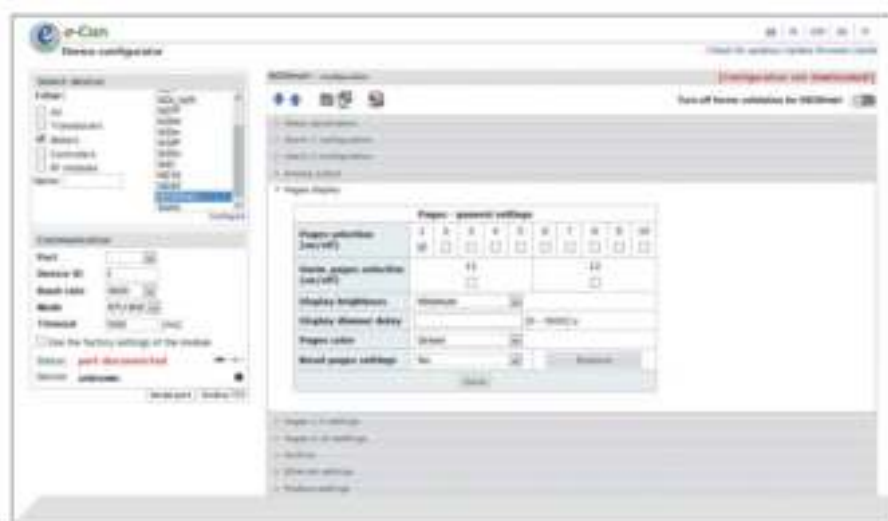

Ability to configure and update ND30PNET with free eCon software (via RS-485)

*Availability of feature depends on hardware version of ND30PNET

Ordering Code

Ordering	Meter ND30PNET -	X	X	X	XX	X	X
Input voltage (phase/phase-to-phase) un:							
3 x 57.7/ 100 V, 3x 230/ 400 V		1					
3 x 110/ 190 V, 3 x 400/ 690 V		2					
Additional outputs /inputs:							
2 relays			1				
2 relays, 1 analogue output, 2 inputs PT100			2				
Supply:							
85...253 V a.c., 90...300 V d.c.				1			
20...40 V a.c., 20...60 V d.c.				2			
Version:							
standard					00		
custom-made*					XX		
Language:							
Polish						P	
English						E	
other*						X	
Acceptance tests:							
without extra quality requirements							0
with an extra quality inspection certificate							1
acc. to customer's request							X

EXAMPLE OF ORDER:

The code **ND30PNET - 1 2 2 1 00 E 0** means:

ND30PNET - meter ND30PNET

1 - input voltage 3 x 57.7/ 100 V, 3x 230/ 400 V

2 - 2 relays, 1 analog output, 2 inputs PT100

1 - supply: 85...253 V a.c., 90...300 V d.c.

00 - standard version

E - user's manual in English

0 - without additional quality requirements.

* - after agreeing with the manufacturer

See Also





Multifunction Meters

Transducers & Isolators

Temperature Controllers

Converters & Recorders

Digital Panel Meters

Current Transformers

Analogue Panel Meters

Shunts

Digital Multimeters

Clamp Meters

Insulation Testers

ND30BAC

METER OF POWER NETWORK PARAMETERS WITH BACnet

Features

- Measurement of 54 power network parameters, including current and voltage harmonics up to 51st, in 1-phase 2-wire or 3-phase 3 or 4-wire balanced and unbalanced systems
- Graphical colour display: LCD TFT 3,5", 320 x 240 pixels, fully configurable by a user (10 views, 8 parameters in each view)
- Indications include the values of programmed ratios
- Memory of minimum and maximum values
- 2 configurable alarm outputs
- Digital output RS-485 - MODBUS protocol
- Modern and user-friendly BACnet/ IP interface
- Programming of parameters using free econ software
- Battery backup RTC
- Overall dimensions: 96 x 96 x 77 mm.

ND30BAC - METER OF POWER NETWORK PARAMETERS WITH BACnet

Example of Application



Measurement and Visualization of Power Network Parameters

- Phase voltages: U_1, U_2, U_3
- Phase-to-phase voltages: U_{12}, U_{23}, U_{31}
- Phase currents i_1, i_2, i_3
- Active phase powers: $P(W)_1, P(W)_2, P(W)_3$
- Reactive phase powers: $Q(\text{Var})_1, Q(\text{Var})_2, Q(\text{Var})_3$
- Apparent phase powers: $S(\text{VA})_1, S(\text{VA})_2, S(\text{VA})_3$
- Active power factors: $\text{PF}_1, \text{PF}_2, \text{PF}_3$
- Three phase total power factor: total 3pf_t
- Reactive/active power factors: $\text{tg}\varphi_1, \text{tg}\varphi_2, \text{tg}\varphi_3$
- Active, reactive and apparent 3-phase power: $P(W), Q(\text{Var}), S(\text{VA})$
- Mean 3-phase power factors: $\text{PF}, \text{tg}\varphi$
- Frequency f
- Mean 3-phase voltage: U_S
- Mean phase-to-phase voltage: U_{MF}
- Mean 3-phase current: i_S
- 15, 30, 60 minutes mean active/reactive/apparent power: $P(W)_{\text{demand}}, Q(\text{Var})_{\text{demand}}, S(\text{VA})_{\text{demand}}$ and mean current i_{demand}
- Mean apparent power $S(\text{VA})_{\text{demand}}$
- Average current i_{demand}
- Active, reactive and apparent 3-phase energy: EnP (Wh) Import & Export, EnQ (Varh) inductive or capacitive, EnS (VAh) ,
- Active, reactive and apparent energy from external counter: EnPE
- Total harmonic content coefficients for phase voltages and currents $\text{THD}_{U1}, \text{THD}_{U2}, \text{THD}_{U3}, \text{THD}_{i1}, \text{THD}_{i2}, \text{THD}_{i3}$ and for 3-phase voltages and currents $\text{THD}_U, \text{THD}_i$
- Harmonics for current and phase voltage up to 51 st!
- kVAR demand
- Memory of minimum and maximum (Peak) values, Voltage (U), Current (I), Active Power (W), Reactive Power (Var), Apparent Power (VA), Power Factor (PF), Frequency (Hz), Demands, Temperature, THD

Features



Inputs



Outputs



Galvanic Isolation



ND30BAC - METER OF POWER NETWORK PARAMETERS WITH BACnet

TECHNICAL DATA

MEASURING RANGE						ACCURACY
Measured value	Measuring range	L1	L2	L3	Z	Class (%) / Basic error (%) class relative to the measured value acc. to EN61557-12
Current I/S A 1 A... 5 A...	0.010...0.100...1.200 A (tr_1=1) 0.050...0.500...6.000 A (tr_1=1) ...20.00 A (tr_1=1)	-	-	-	-	Class 0.2
Voltage U-W 37.7 V... 230 V... 400 V...	5.7...11.5...25.0 V (tr_U=1) 23.0...46...75.0 V (tr_U=1) 40.0...80...480.0 V (tr_U=1) ...480.0 kV (tr_U=1)	-	-	-	-	Class 0.2
Voltage U-L 100 V... 400 V... 800 V...	10.0...20...120.0 V (tr_U=1) 40.0...80...480.0 V (tr_U=1) 99.0...138...830.0 V (tr_U=1) ...830.0 kV (tr_U=1)	-	-	-	-	Class 0.5
Active power P _a , average active power P _{av}	... (-)1999.9 W ... (-)1999.9 MW (tr_U=1, tr_I=1)	-	-	-	-	Class 0.5
Reactive power Q	... (-)1999.9 Var ... (-)1999.9 MVar (tr_U=1, tr_I=1)	-	-	-	-	Class 1
Apparent power S _a , average apparent power S _{av}	...1999.9 VA ...1999.9 MVA (tr_U=1, tr_I=1)	-	-	-	-	Class 0.5
Active energy EnP (imported or exported)	... (-)1999.9 Wh ... (-)1999.9 MWh (tr_U=1, tr_I=1)	-	-	-	-	Class 0.5
Reactive energy EnQ (inductive or capacitive)	... (-)1999.9 Varh ... (-)1999.9 MVarh (tr_U=1, tr_I=1)	-	-	-	-	Class 1
Apparent energy EnS	...1999.9 VAh ...1999.9 MVAh (tr_U=1, tr_I=1)	-	-	-	-	Class 0.5
Active power factor PF _a	-1.00...0...1.00	-	-	-	-	± 0.01 of basic error
Coefficient tanφ (ratio of reactive power to active power)	-1.20...0...1.20	-	-	-	-	± 0.01 of basic error
Frequency f	45.00...65.00 Hz	-	-	-	-	Class 0.1
Total harmonic distortion of voltage THDU and current THDI	0.0...100.0 %	-	-	-	-	Class 5 50 / 60 Hz
Amplitudes of the voltage U _{u1} ...U _{un1} and current I _{u1} ...I _{un1}	0.0...100.0 %	-	-	-	-	Class 5 50 / 60 Hz

tr_1, tr_U – ratio of current and voltage transformer

DIGITAL INTERFACE

Interface type	Transmission protocol		Remarks
RS-485	Modbus RTU (B2,SE 1,80-1,0W1)	Address 1...247	baud rate: 4.8, 9.6, 19.2 kbit/s, 57.6, 115.2 kbit/s
BACnet	BACnet/IP		

ND30BAC - METER OF POWER NETWORK PARAMETERS WITH BACnet

EXTERNAL FEATURES

Readout field	graphic color display LCD TFT 3,5" - 320 x 240 pixels	
Overall dimensions	96 x 96 x 77 mm	mounting hole 92,5 x 92,5 mm
Weight	0,3 kg	
Protection grade	from frontal side: IP65	from terminal side: IP20

RATED OPERATING CONDITIONS

Supply voltage	→ 85...253 V a.c. (40...50...400 Hz), 90...300 V d.c. or 20...40 V a.c., 20...60 V d.c.	power consumption ≤ 6 W
Power consumption	in voltage circuit ≤ 0,2 VA	in current circuit ≤ 0,1 VA
Input signal	0...8,1...1,2 In; 0,1...0,2...1,2 Un for current, voltage, PF, typ.	frequency 45...50...65 Hz, sinusoidal (THD ≤ 8%)
Power factor	0...0...1	
Preheating time	5 min.	
Ambient temperature	-10...23...55°C, class K55 acc. to EN61557-12	
Humidity	0...80...95%	without condensation
Operating position	any	
External magnetic field	≤ 60...400 A/m a.c.	≤ 3 A/m a.c. 50/60 Hz
Short-term overload	voltage input: 2 In (5 sec.)	current input 50 A (1 sec.)
Admissible crest factor	current: 2	voltage: 2
Additional error (in % of the intrinsic error)		from ambient temperature change: < 0,3% / 10°C

SAFETY AND COMPABILITY REQUIREMENTS

Electromagnetic compatibility	noise immunity	acc. to EN 61000-6-2
	noise emissions	acc. to EN 61000-6-4
Isolation insured by the casing	double	acc. to EN 61010-1
Isolation between circuits	basic	acc. to EN 61010-1
Isolation level	2	acc. to EN 61010-1
Installation category	III	acc. to EN 61010-1
Maximal phase-to-earth voltage	<ul style="list-style-type: none"> for supply circuit and relay outputs: 300 V for measuring input: 500 V for circuits of RS-485, Ethernet, pulse input and output, analog outputs: 50 V 	acc. to EN 61010-1
Altitude a.s.l.	< 2000 m	

CONNECTION DIAGRAMS

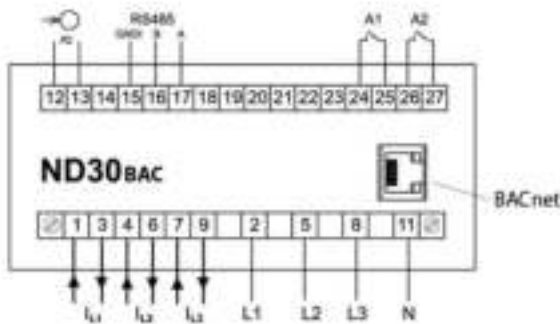

Description of meter connections strips

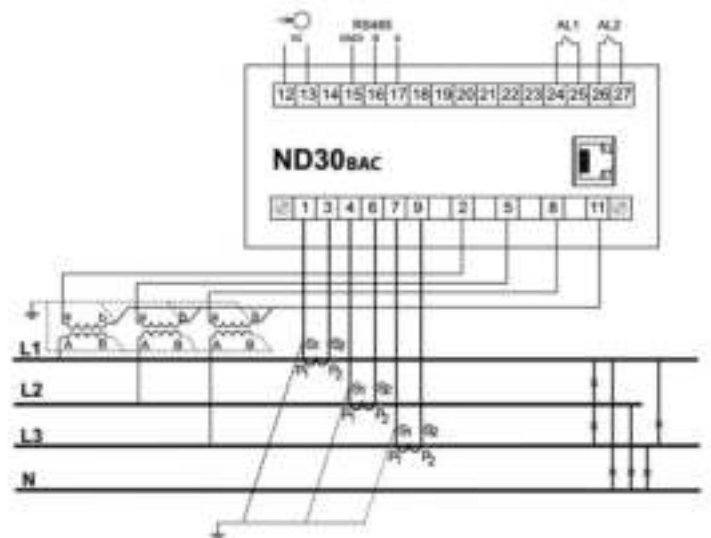

Indirect measurement in 4-wire network - connection of input signals

ND30BAC - METER OF POWER NETWORK PARAMETERS WITH BACnet

DISPLAING OF MEASUREMENT PARAMETERS



up to 10 programmable screens (8 parameters per page);
ability to change color for all screens



Available colors for digital indications:



two screens dedicated to harmonics;
indication of individual harmonic for voltages and currents (up to 51st);
bargraph presentation for all harmonics with zoom function



easy to use and intuitive menu;
information bar with status of: phase sequence, alarm outputs and interfaces, time and date

ND30BAC - METER OF POWER NETWORK PARAMETERS WITH BACnet

METER CONFIGURATION WITH FREE eCON SOFTWARE



ability to configure and update ND30BAC with free eCon software (via RS-485)

ORDERING CODE

Meter ND30BAC -	X	X	X	X	XX	X	X
Input voltage (phase/phase-to-phase) Un:							
3 x 57.7/ 100 V, 3 x 230/ 400 V	1						
3 x 110/ 190 V, 3 x 400/ 690 V	2						
Additional outputs /inputs:							
2 relays		1					
Interface:							
BACnet/IP and RS485(Modbus RTU)			2				
Supply:							
85...253 V a.c., 90...300 V d.c.				1			
20...40 V a.c., 20...60 V d.c.				2			
Version:							
standard					00		
custom-made*					XX		
Language:							
Polish						P	
English						E	
other*						X	
Acceptance tests:							
without additional quality requirements							0
with an extra quality inspection certificate							1
acc.to customer's request*							X

* only after agreeing with the manufacturer

Order example:

The code **ND30BAC - 1 1 2 1 00 E 0** means:

- ND30BAC** - meter ND30BAC
- 1** - input voltage 3 x 57.7/ 100 V, 3x 230/ 400 V
- 1** - 2 relays
- 2** - BACnet/IP and RS485(Modbus RTU)
- 1** - supply: 85...253 V a.c., 90...300 V d.c.
- 00** - standard version
- E** - user's manual in English
- 0** - without additional quality requirements.

ND30BAC - METER OF POWER NETWORK PARAMETERS WITH BACnet

SEE ALSO:



ND40 - power network analyzer/recorder



RE92 - dual loop controller



P30U - universal transducer of temperature and standard signals



KS31 - digital synchronizing unit



N43 - rail mounted 3-phase power network meter



P43 - 3-phase transducer of power network parameters



ND1 - analyser of network parameters



Current transformers from 5 A up to 6 kA



ND30 - METER OF POWER NETWORK PARAMETERS

ND30IoT - METER OF POWER NETWORK PARAMETERS FOR IoT APPLICATIONS

- **Measurement** of 54 power network parameters, including **current and voltage harmonics up to 63rd** in 1-phase 2-wire or 3-phase 3 or 4-wire balanced and unbalanced systems.
- **The MQTT protocol is ideal for communication in distributed acquisition systems data - IoT applications (ND30IoT).**
- **High accuracy class (0.2S for active energy).**
- **Graphical color display:** LCD TFT 3,5", 320 x 240 pixels, **fully configurable by a user** (10 views, 8 parameters in each).
- **Additional 2 pages for harmonics presentation and 1 dedicated page for visualization in the form of an analog meter.**
- Indications include the values of programmed ratios.
- Memory of minimum and maximum values.
- 2 configurable alarm outputs.
- Optional: analog output 0/4...20 mA and 2 PT 100 inputs (eg. for measurement of transformer temperature), 2 galvanically isolated binary inputs 0/5...24V d.c.
- Archiving of up to 32 measured parameters in the internal memory 8 GB (option).
- Digital output RS-485 - MODBUS protocol.
- **Modern and user-friendly Ethernet interface 10/100 BASE-T (option):**
 - protocol: MODBUS TCP/IP, HTTP, FTP,
 - protocol: MQTT (**ND30IoT**),
 - services: www server, ftp server, DHCP client.
- Programming of parameters using **free eCon software**.
- Battery backup RTC.
- Overall dimensions: 96 x 96 x 77 mm.
- **Supervisory relay mode for alarm outputs (ND30 and ND30IoT)**
- **MQTT protocol (for ND30)**

Remarks:

- New features available from 1.07 firmware version.
- To make functions active, order appropriate licence key – details in ordering code.
- Functions can be also activated on the devices which have been already installed on the facility after software upgrade.

EXAMPLE OF APPLICATION

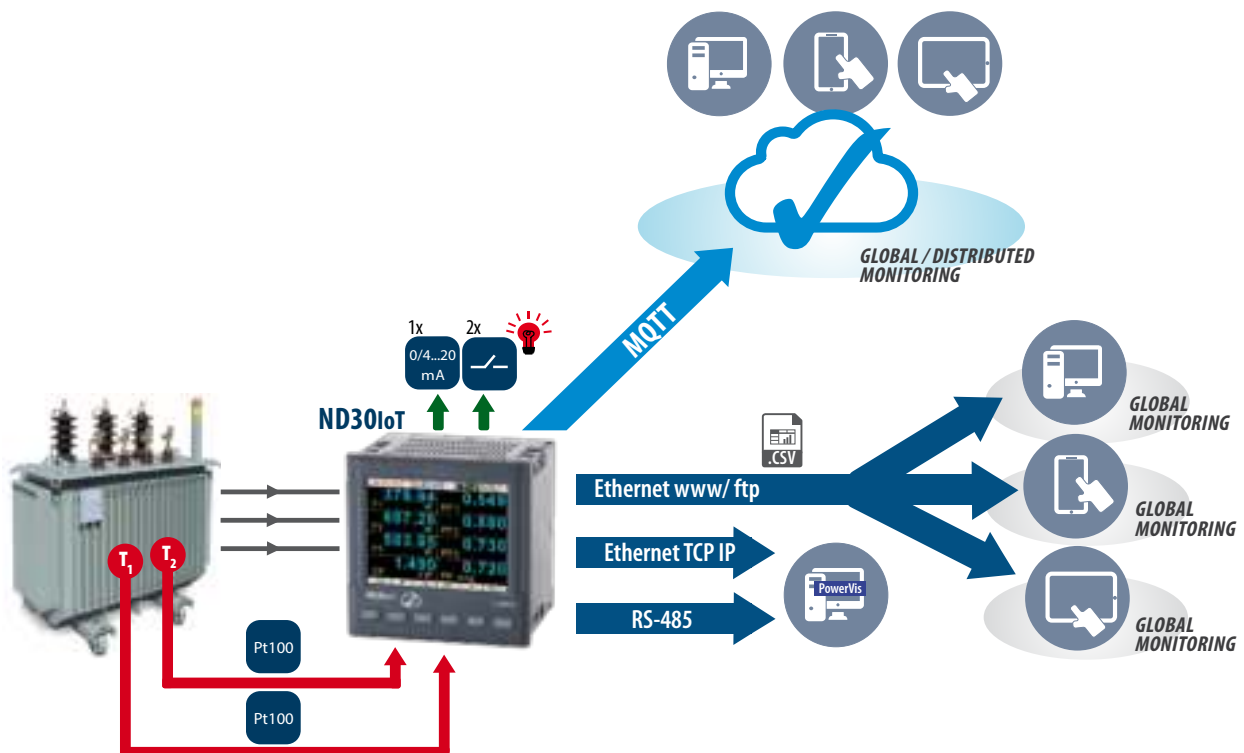

EXAMPLE OF APPLICATION

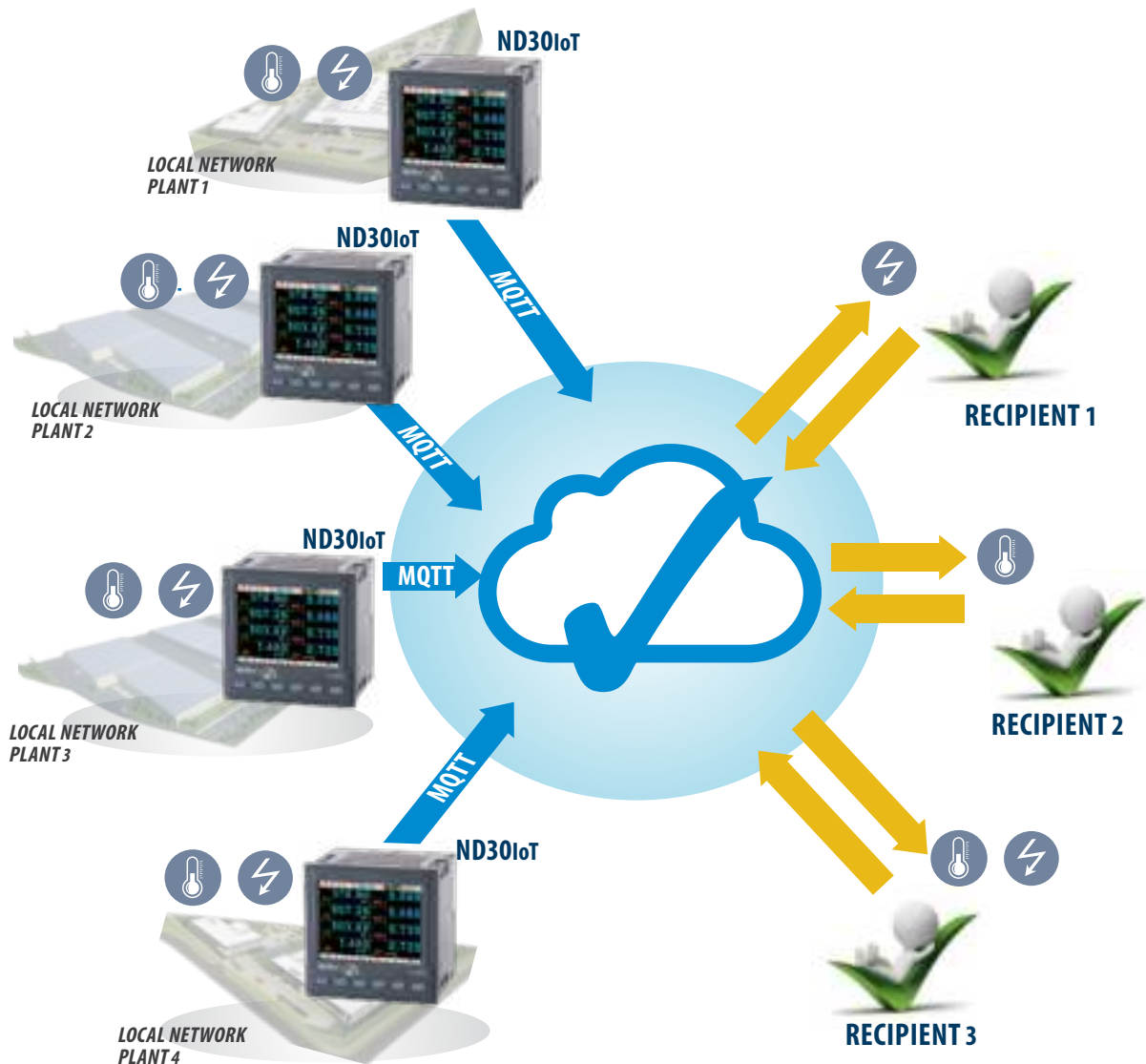

MEASUREMENT AND VISUALIZATION OF POWER NETWORK PARAMETERS

- phase voltages: U_1, U_2, U_3
- phase-to-phase voltages: U_{12}, U_{23}, U_{31}
- phase currents I_1, I_2, I_3
- active phase powers: P_1, P_2, P_3
- reactive phase powers: Q_1, Q_2, Q_3
- apparent phase powers: S_1, S_2, S_3
- active power factors: PF_1, PF_2, PF_3
- reactive/active power factors: $tg\phi_1, tg\phi_2, tg\phi_3$
- active, reactive and apparent 3-phase power: P, Q, S
- mean 3-phase power factors: $PF, tg\phi$
- frequency f
- mean 3-phase voltage: U_s
- mean phase-to-phase voltage: U_{mf}
- mean 3-phase current: I_s
- 15, 30, 60 minutes' mean active power: P_{demand}
- mean apparent power S_{demand}
- average current I_{demand}
- active, reactive and apparent 3-phase energy: EnP, EnQ, EnS
- active, reactive and apparent energy from external counter: $EnPE$
- total harmonic content coefficients for phase voltages and currents $THD_{U1}, THD_{U2}, THD_{U3}, THD_{I1}, THD_{I2}, THD_{I3}$ and for 3-phase voltages and currents THD_v, THD_i
- harmonics for current and phase voltage up to 63rd!
- temperature (2 x Pt100 input)

ND30, ND30IoT - METER OF POWER NETWORK PARAMETERS



FEATURES	INPUTS	OUTPUTS	GALVANIC ISOLATION

TECHNICAL DATA

MEASURING RANGE

Measured value	Measuring range	L1	L2	L3	Σ	Class
Current I/5 A 1 A~ 5 A~	0.002 ..0.100..1.200 A 0.010 ..0.500.. 6.000 A ...100.00 kA (tr _I ≠1)	•	•	•		0.2 (EN 61557-12)
Voltage L-N 57.7 V~ 110 V~ 230 V~ 400 V~	5.700..11.500 ..70.000 V 11.000..22.000 ..132.00 V 23.000..46.000 .. 276.00 V 40.000..80.000 .. 480.00 V ...1920.0 kV	•	•	•		0.2 (EN 61557-12)
Voltage L-L 100 V~ 190 V~ 400 V~ 690 V~	10.000 ..20.000..120.00 V 19.000 ..38.000..228.00 V 40.000..80.00 .. 480.00 V 69.000..138.00 .. 830.00 V ...1999.0 kV (tr _U ≠1)	•	•	•		0.5 (EN 61557-12)
Active power P	-19999 MW .. 0,000 W19999 MW (tr _U ≠1, tr _I ≠1)	•	•	•	•	0.5 (EN 61557-12)
Reactive power Q	-19999 MVar .. 0,000 Var19999 MVar (tr _U ≠1, tr _I ≠1)	•	•	•	•	1 (EN 61557-12)
Apparent power S	0.000 .. 1999,9 VA19999 MVA (tr _U ≠1, tr _I ≠1)	•	•	•	•	0.5 (EN 61557-12)
Active energy EnP (imported or exported)	0.000 .. 99 999 999,999 kWh				•	0.25 (EN 62053-22)
Reactive energy EnQ (inductive or capacitive)	0.000 .. 99 999 999,999 kVarh				•	1 (EN 61557-12)
Apparent energy EnS	0.000 .. 99 999 999,999 kVAh				•	0.5 (EN 61557-12)
Active power factor PF	-1.00 ..0 ..1.00	•	•	•	•	1 (EN 61557-12)
Coefficient tg (ratio of reactive power to active power)	-999.99...-1.20 .. 0 .. 1.20...999.99	•	•	•	•	1
Frequency f	45.00...65.000... 100.00 Hz				•	0.1 (EN 61557-12)
Total harmonic distortion of voltage THDU and current THDI	0.0 ..100.0 %	•	•	•	•	5 (EN 61557-12)
Amplitudes of the voltage U _{h2} ...U _{h63} and current I _{h2} ... I _{h63}	0.0 ..100.0 %	•	•	•		II (IEC61000-4-7)

tr_I - Current transformer ratio = Transformer primary current / Current transformer secondary current

tr_U - Voltage transformer ratio = Transformer primary voltage / Voltage transformer secondary voltage

ADDITIONAL INPUTS

Input type	Properties
Input Pt100 (T1, T2) - option	2 x Pt100, 2-wire, -50...400°C, basic error 0.5 %
Binary inputs - option	0 V d.c. – binary input inactive, 5...24 V d.c. – binary input active

DIGITAL INTERFACE

Interface type	Transmission protocol	Remarks
RS-485	Modbus RTU 8N2,8E1,8O1,8N1	Address 1..247 baud rate: 4.8, 9.6, 19.2 38.4, 57.6, 115.2 kbit/s
	Modbus TCP,HTTP,FTP	
Ethernet 10/100 Base-T -option	MQTT	WWW server, FTP server, DHCP client

EXTERNAL FEATURES

Readout field	graphic color display LCD TFT 3,5", 320 x 240 pixels	
Overall dimensions	96 x 96 x 77 mm	mounting hole 92.5 x 92.5 mm
Weight	0.3 kg	
Protection grade	from frontal side: IP65	from terminal side: IP20

RATED OPERATING CONDITIONS

Supply voltage	→ 85...253 V a.c. (40...50...400 Hz), 90...300 V d.c. or 20...40 V a.c., 20...60 V d.c.	power consumption ≤ 6 VA
Power consumption	in voltage circuit ≤ 0.2 VA	in current circuit ≤ 0.1 VA
Input signal	0...0.1...1.2 In; 0.1...0.2...1.2 Un for current, voltage, PF, tgφ,	frequency 45...50...60...100 Hz, sinusoidal (THD ≤ 8%)
Power factor	-1...0...1	
Preheating time	5 min.	
Ambient temperature	-10...23...55°C, class K55 acc. to EN61557-12	
Humidity	0...40...65...95%	without condensation
Operating position	any	
External magnetic field	≤ 40...400 A/m d.c.	≤ 3 A/m a.c. 50/60 Hz
Short-term overload	voltage input: 2 Un (5 sec.)	current input 50 A (1 sec.)
Admissible crest factor	current: 2	voltage: 2
Additional error (in % of the intrinsic error)		from ambient temperature change: < 50% / 10°C

SAFETY AND COMPABILITY REQUIREMENTS

Electromagnetic compatibility	noise immunity	acc. to EN 61000-6-2
	noise emissions	acc. to EN 61000-6-4
Isolation insured by the casing	double	acc. to EN 61010-1
Isolation between circuits	basic	acc. to EN 61010-1
Polution level	2	acc. to EN 61010-1
Installation category	III	acc. to EN 61010-1
Maximal phase-to-earth voltage	<ul style="list-style-type: none"> for supply circuit and relay outputs 300 V for measuring input 500 V for circuits of RS-485, Ethernet, pulse input and output, analog outputs: 50 V 	acc. to EN 61010-1
Altitude a.s.l.	< 2000 m	

CONNECTION DIAGRAMS

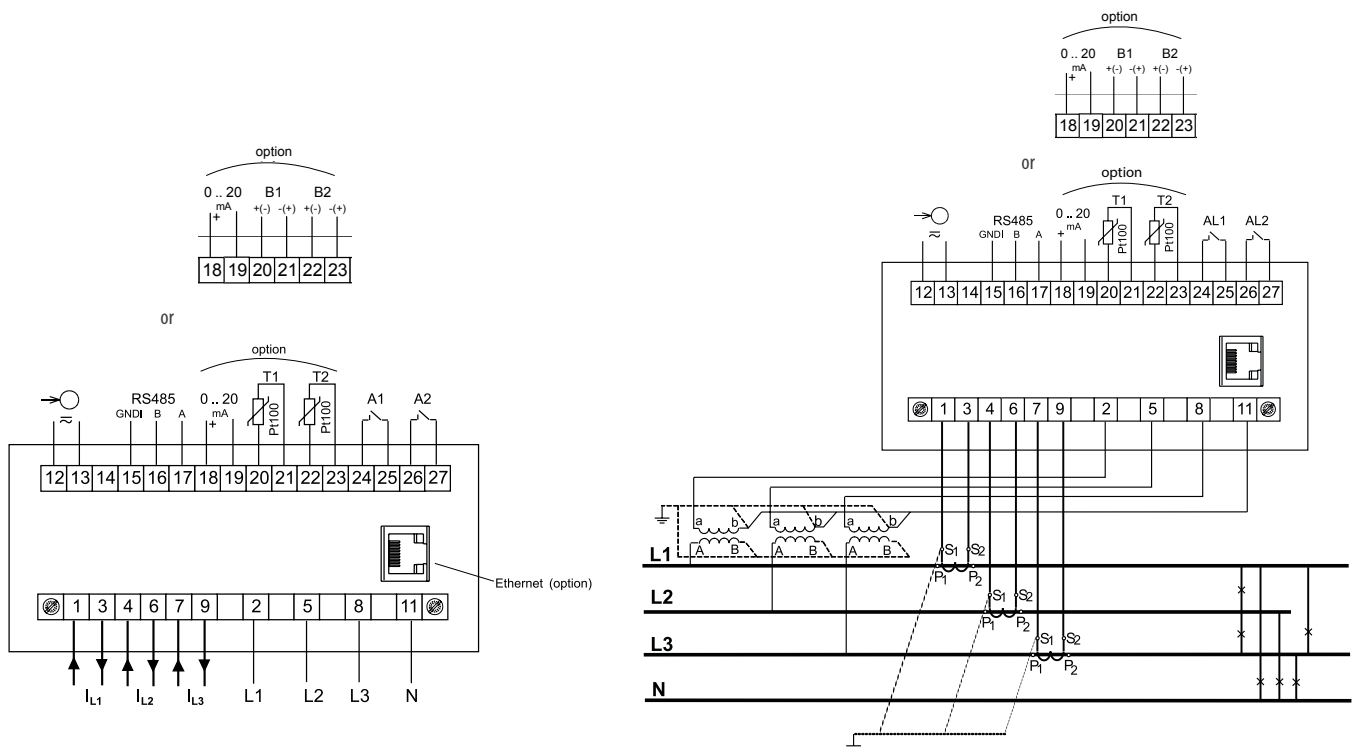

Description of meter connections strips

Indirect measurement in 4-wire network - connection of input signals



DISPLAING OF MEASUREMENT PARAMETERS



up to 10 programmable screens
(8 parameters per page);
ability to change color for all screens

Available colors for digital indications:

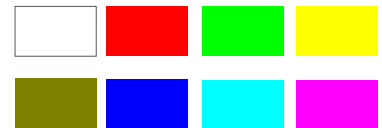

two screens dedicated to harmonics;
indication of individual harmonic
for voltages and currents (up to 51st);
bargraph presentation for all harmonics
with zoom function



presentation in the form of analog
meter view with min/max preview
for display value and zoom function



easy to use and intuitive menu;
information bar with status of: phase
sequence, alarm outputs, temperature
measurements*, archiving and memory*,
Ethernet* and RS-485 interfaces,
time and date

*- availability of feature depends on
hardware version of ND30IoT, ND30



METER CONFIGURATION WITH FREE eCON SOFTWARE

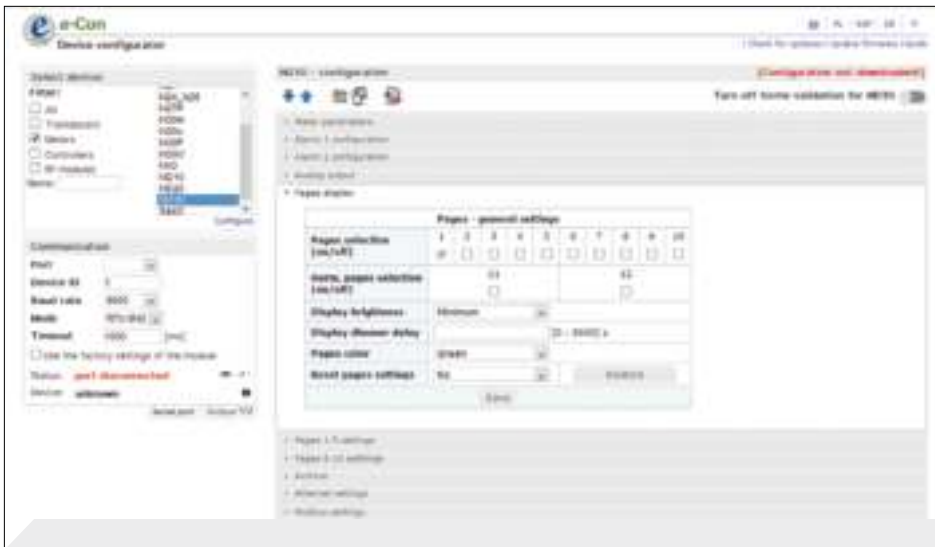

ability to configure and update ND30IoT, ND30 with free eCon software (via RS-485 or Ethernet* interface)

*- availability of feature depends on hardware version of ND30IoT, ND30

REMOTE READOUT OF PARAMETERS THROUGH ETHERNET: WWW SERVER, FTP

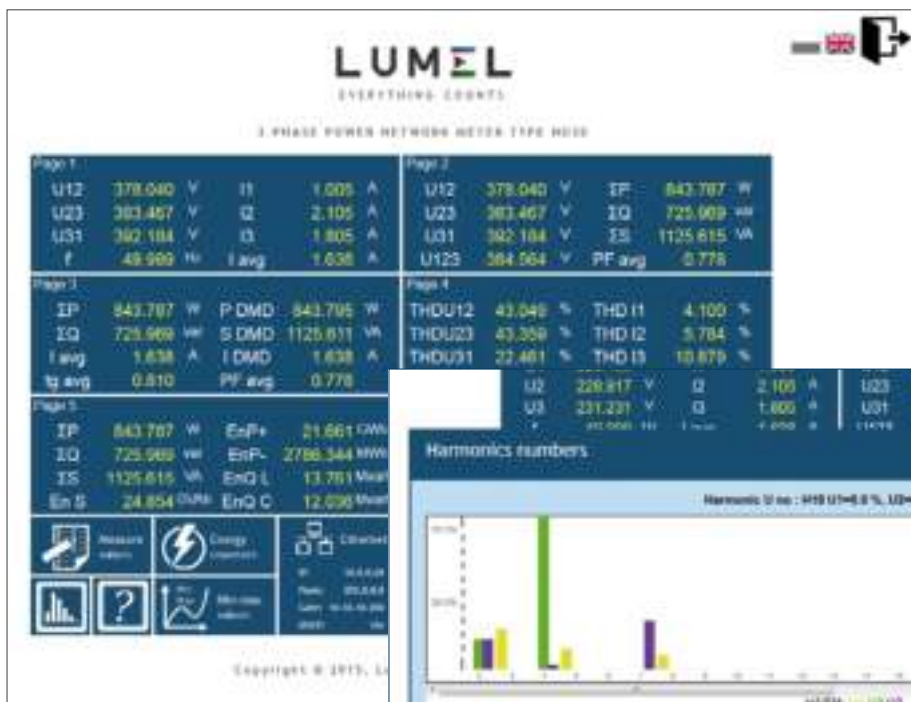

WEB server* for remote reading of current measurement data; FTP server* for downloading archived CSV files

*- availability of feature depends on hardware version of ND30IoT, ND30



ORDERING CODE

Code	Description
ND30IoT 1121MSMO	Power network meter (MQTT) ND30IoT type Input current 1A/5A, X/1A, X/5A Input voltage 3x57.7/100V, 3x230/400V 2x relays, Ethernet and RS-485 interface, internal memory 8GB, supply 85-253V a.c. or 90-300V d.c., MQTT protocol, Supervisory relay, documentation and descriptions in Polish and English version, test certificate
ND30IoT 2222MSMO	Power network meter (MQTT) ND30IoT type Input current 1A/5A, X/1A, X/5A, Input voltage 3x110/190V, 3x400/690V 2x relays, 1x analog output 0-20mA, 2x Pt100 input Ethernet and RS-485 interface, internal memory 8GB, supply 20-40V a.c. or 20-60V d.c., MQTT protocol, Supervisory relay, documentation and descriptions in Polish and English version, test certificate
ND30IoT 1221MSMO	Power network meter (MQTT) ND30IoT type Input current 1A/5A, X/1A, X/5A, Input voltage 3x57.7/100V, 3x230/400V 2x wyj. relays, 1x wyj. analogowe 0-20mA, 2x wej. Pt100 Ethernet and RS-485 interface, internal memory 8GB, supply 85-253V a.c. or 90-300V d.c., MQTT protocol, Supervisory relay, documentation and descriptions in Polish and English version, test certificate
ND30IoT 2221MSMO	Power network meter (MQTT) ND30IoT type Input current 1A/5A, X/1A, X/5A, Input voltage 3x110/190V, 3x400/690V 2x wyj. relays, 1x wyj. analogowe 0-20mA, 2x wej. Pt100 Ethernet and RS-485 interface, internal memory 8GB, supply 85-253V a.c. or 90-300V d.c., MQTT protocol, Supervisory relay, documentation and descriptions in Polish and English version, test certificate
ND30IoT 1122MSMO	Power network meter (MQTT) ND30IoT type Input current 1A/5A, X/1A, X/5A, Input voltage 3x57.7/100V, 3x230/400V 2x relays, Ethernet and RS-485 interface, internal memory 8GB, supply 20-40V a.c. or 20-60V d.c., MQTT protocol, Supervisory relay, documentation and descriptions in Polish and English version, test certificate
ND30IoT 2121MSMO	Power network meter (MQTT) ND30IoT type Input current 1A/5A, X/1A, X/5A, Input voltage 3x110/190V, 3x400/690V 2x relays, Ethernet and RS-485 interface, internal memory 8GB, supply 85-253V a.c. or 90-300V d.c., MQTT protocol, Supervisory relay, documentation and descriptions in Polish and English version, test certificate

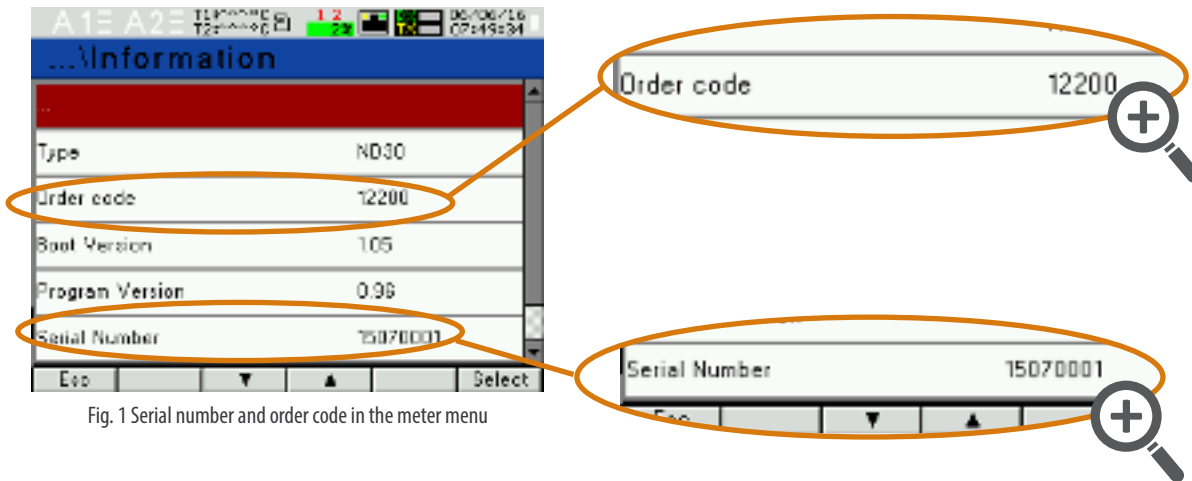

Fig. 1 Serial number and order code in the meter menu

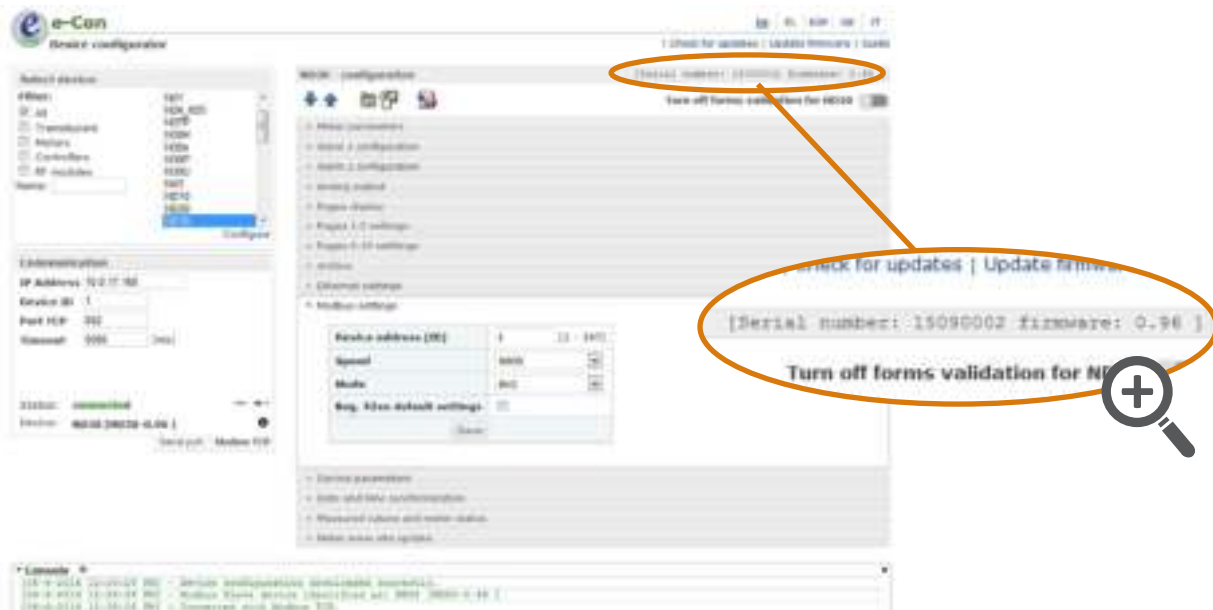

Fig. 2 Serial number in the eCon software bar



Sifam Tinsley Instrumentation Inc.
3105, Creekside Village Drive, Suite No.
801, Kennesaw,
Georgia 30144 (USA)
E-mail Id : psk@sifamtinsley.com Web :
www.sifamtinsley.com Contact No. : +1
404 736 4903