



Technical Data Sheet

Alpha 20



File No. E471457



Alpha 20 is a compact multifunction instrument which Measures important electrical parameters in 3 phase 4 Wire and 3 phase 3 Wire Network & replaces the multiple analog panel meters.

Special Features

- MODBUS (RS-485) Communication (optional)
- Pulse/Limit Switch output (optional)
- 3 Line 4 Digits ultra bright LED Display (up to 9999)
- On site Programmable CT/PT Ratios
- User selectable CT Secondary 1A/5A
- User selectable PT Secondary from 100 VLL to 500 VLL
- Programmable Energy format & Energy rollover count
- Wide auxillary Power Supply which can accept any input between 40V - 300V AC/DC

Application

Alpha 20 Measures important electrical parameters in 3 phase 4 Wire and 3 phase 3 Wire Network & replaces the multiple analog panel meters. It measures electrical parameters like AC Voltage, AC Current, Frequency, Active, Reactive, Apparent Power, Import Export Energy & many more.

Product Features

On site programmable PT/CT ratios	It is possible to program primary of external potential Transformer (PT), primary of external Current Transformer (CT) on site via front panel keys by entering into Programming mode.	Optional Pulse Output / Limit switch (Relay output)	The instrument can be programmed as Pulse output or Limit switch.
User selectable CT Secondary 5A /1A	The secondary of external Current Transformer (CT) can be programmed on site to either 5A or 1A using front panel keys.	Pulse Output	The optional pulse output is a potential free, very fast acting relay contact which can be used to drive an external mechanical counter for energy measurement.
User selectable PT Secondary	The secondary of external Potential Transformer (PT) can be programmed on site from 100VLL to 500VLL using front panel keys. User can set the display in auto scrolling mode or fixed screen mode using front panel keys.	Limit Switch	The instrument will trip the relay if the programmed parameter exceeds the programmed Trip Limits.
Low back depth	The instrument has very low back depth (behind the panel) of less than 55 mm (Without output option).	Optional MODBUS (RS485) Output	The optional Modbus output enables the instrument to transmit all the measured parameters over standard MODBUS (RS-485).
Four function keys	Using the four function key, it is possible to go desired parameter screen instantly..	Configuration of Instrument via MODBUS	The instrument setting can be configured locally via front panel keys by entering into the programming mode or remotely via MODBUS RS-485 Note: The MODBUS communication parameters can only be set locally via front panel keys in programming mode.
Demand Measurement	Measures & Displays Current Demand, kVA Demand, kW Import Demand, kW Export Demand. Any of the parameters can be assigned to optional Limit switch.	Storage of parameters possible	The instrument stores minimum and maximum values for System Voltage, System Current, Run Hour, ON Hour & number of Interrupts. Every 60 sec stored values are updated.
3 line 4 digits LED display	Simultaneous display of 3 Parameters.	Enclosure Protection for dust and water	Conforms to IP 50 (for front face) & IP 20 (for back) IP 65 (for front with seal) as per IEC60529.
RPM Measurement	The instrument display Rotation per minutes for generator applications. Number of poles can be set on site depending upon application requirement.	EMC Compatibility	Compliance to International standard IEC 61326.
Energy Count Storage	In case of power failure, the instrument memorizes the last energy count. Every 1 min, the instrument updates the energy counter in the non-volatile memory.	Interference Emission	IEC 61326-1 : 2005, Class A
User selectable 3 phase 3 Wire or 4Wire or Single phase Network	User can program on site the network connection as either 3 Phase 3 Wire or 4 Wire or single phase network using front panel keys. In case of self powered configuration either 3 Phase 4 wire or single phase network is available.	Interference Immunity	IEC 61326-1 : 2005
Onsite selection of Auto scroll / Fixed Screen	User can set the display in auto scrolling mode or fixed screen mode using front panel keys.	Electrostatic discharge contact /air. (ESD)	IEC 61000-4-2 -- 4kV/8kV
		EM Field	IEC 61000-4-3 -- 10 V/m (80 MHz to 1 GHz) - 3 V/m (1.4 Ghz to 2 GHz) -- 1 V/m (2 GHz to 2.7 GHz)

Product Features

True RMS measurement	The instrument measures distorted wave form up to 15th Harmonic.
Energy Measurement (Import & Export)	Active Energy (kWh), Reactive Energy (kVArh), Apparent Energy (kVAh). Any of the parameters can be assigned to optional Pulse output.
Programmable Energy format & Energy rollover count	Customer can assign the format for energy display on MODBUS (RS-485) in terms of W, kW or MW. Additional to this, customer can also set a rollover count from 7 to 14 digits depending on the energy format, after which the energy will roll back to zero.

Burst	IEC 61000-4-4 -- 2 kV (5/50 ns, 5 kHz)
Surge	IEC 61000-4-5 -- 1 kVLL / 2 kVLN.
Conducted RF	IEC 61000-4-5 -- 3 V (150 kHz to 80 MHz)
Rated Power Frequency magnetic Field	IEC 61000-4-8 -- 30 A/m
Voltage dip	IEC 61000-4-11 -- 0% during 1 cycle. -- 40% during 10/12 cycles. -- 70% during 25/30 cycles.
Short interruptions cycles.	IEC 61000-4-11 -- 0% during 25/30 cycles. 25 cycles for 50 Hz test. 30 cycles for 60 Hz test.

Technical Specifications

Reference conditions for Accuracy	
Reference temperature	23°C +/- 2°C
Input waveform	Sinusoidal (distortion factor 0.005)
Input frequency	50 or 60 Hz ±2%
Auxiliary supply voltage	Rated Value ±1%
Auxiliary supply frequency	Rated Value ±1%
Voltage Range	20... 100% of Nominal Value.
Current Range	10... 100% of Nominal Value.
Power	Cos phi / sin phi = 1 for Active / Reactive Power & Energy. 10... 100% of Nominal Current & 20... 100% of Nominal Voltage.
Power Factor / Phase Angle	40... 100% of Nominal Current & 20... 100% of Nominal Voltage.

Accuracy	
Voltage	± 0.5% of Nominal Value.
Current	± 0.5% of Nominal Value.
Frequency	0.5% of mid frequency
Active Power	± 1% of Nominal Value.
Re-Active Power	± 1% of Nominal Value.
Apparent Power	± 1% of Nominal Value.
Active Energy	± 1%
Reactive Energy	± 1%
Apparent Energy	± 1%
Power Factor	2% of Unity
Phase angle	2% of range

Measurement error is normally much less than error specified above. Variation due to influence quantity is less than twice the error allowed for reference condition.

Dimension Details

With optional MODBUS / Limit switch

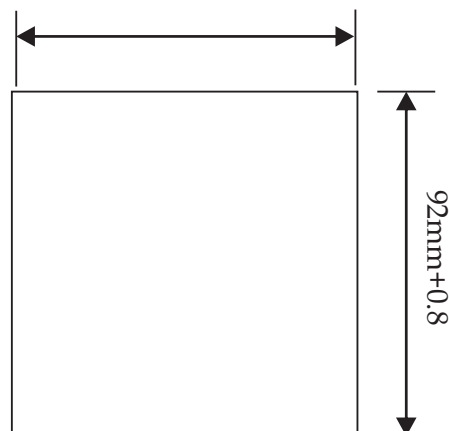
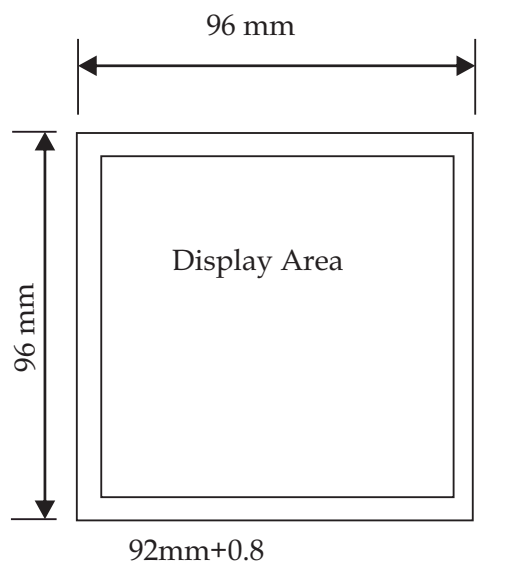

Panel Cutout

Technical Specifications

Input Voltage	
Nominal input voltage (AC RMS)	Phase -Neutral 290V L-N , Line-Line 500V L-L
Max continuous input voltage	120% of rated value
Nominal input voltage burden	< 0.3 VA approx. per phase (For external auxiliary meter)
System PT secondary values	100VLL to 500VLL programmable on site.
System PT primary values	100VLL to 692kVLL programmable on site.

Input Current	
Nominal input current	5A / 1A AC RMS
System CT secondary values	1A & 5A programmable on site
System CT primary values	From 1A up to 9999A (for 1 or 5 Amp)
Max continuous input current	120% of rated value
Nominal input current burden	< 0.2 VA approx. per phase

Auxiliary Supply	
External Aux	40 V - 300V AC-DC (± 5 %)
Self powered	input voltage range from 80% to 100% of Rated value. (Self powered meter is available only in 3Phase 4 Wire and Single Phase network.) Auxiliary input is derived from Phase 1 (R phase)
Frequency range	45 to 65 Hz
VA burden	< 4 VA Approx.

Overload Withstand	
Voltage	2 x rated value for 1 second, repeated 10 times at 10 second intervals
Current	20x rated value for 1 second, repeated 5 times at 5 min intervals

Operating Measuring Ranges	
Voltage Range With External Aux	10... 120% of rated value
Voltage Range With Self Power	80... 120% of rated value
Current Range	10 ... 120% of rated value
Frequency	45...65 Hz.
Power Factor	0.5 Lead ... 1 ... 0.5 Lag.

Dimension Details

With optional MODBUS / Limit switch

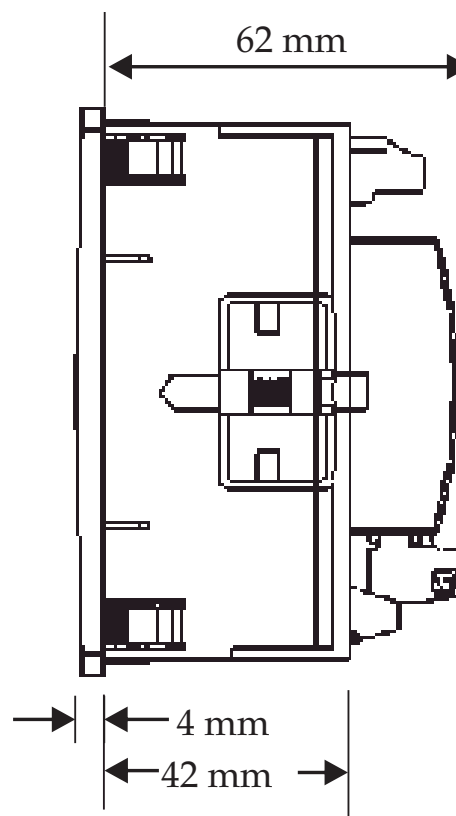
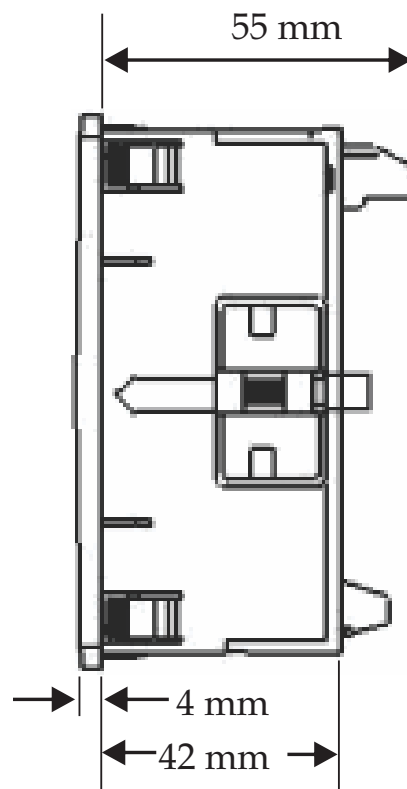

Technical Specifications

Limit Switch (Relay)

Switching Voltage & Current for Relay	240 VDC ,5 A (1NO+1NC)
---------------------------------------	------------------------

Influence of Variations

Temperature coefficient	0.025%/°C for Voltage 0.05%/°C for Current
-------------------------	---

Display update rate

Response time to step input	1 sec approx.
-----------------------------	---------------

Applicable Standards

EMC	IEC 61326-1: 2005
Safety	IEC 61010-1-2001 , Permanently connected use
IP for water & dust	IEC60529

Safety

Pollution degree	2
Installation category	III
High Voltage Test	4.7 kV DC, for 1 minute between Aux. and measuring inputs

Environmental

Operating temperature	-20 to +70°C
Storage temperature	-30 to +80°C
Relative humidity	0 to 95% non condensing
Warm up time	Minimum 3 minute
Shock	15g in 3 planes
Vibration	10... 55 Hz, 0.15mm amplitude

Enclosure

Front	IP 50
Front with seal (Option)	IP 65
Back	IP 20

Dimensions and Weights

Bezel size	96 mm x 96 mm DIN 43 718.
Panel cut-out	92 +0.8 mm x 92 + 0.8 mm.
Overall depth	55 mm.(without output option)
Panel Thickness	1 - 3 mm for self clicking, 1 - 6 mm for swivel screws.
Weight	320 gm. Approx.(with output option)

Installation

Easy Clip in Installation on Panel.

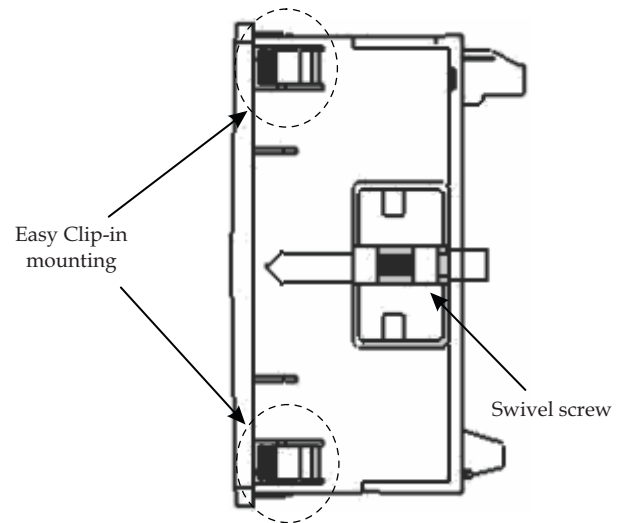

Panel Thickness : 1 - 3 mm for self clicking,
1 - 6 mm for swivel screws.

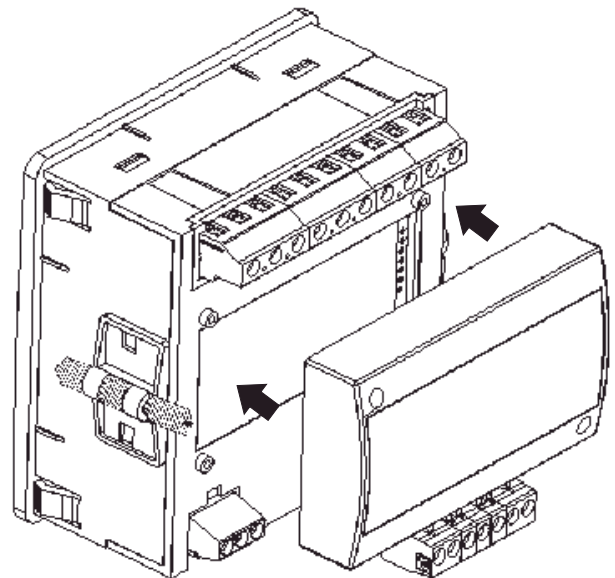

Optional Limit Switch pluggable module.

Technical Specifications

Pulsed Output Option

Energy (can be programmed for different energy parameters simultaneously)

Relay contact	(1NO+1NC)
Switching Voltage & current for Relay	240 VDC ,5 A

Default pulse rate divisor

1 per Wh (up to 3600W)	1 per kWh (up to 3600kWh)	1 per MWh (above 3600kW)
------------------------	---------------------------	--------------------------

Other Pulse rate divisors (applicable only when Energy on RS485 is in W)

10	1 per 10 Wh (up to 3600W)	1 per 10 kWh (up to 3600kWh)	1 per 10 MWh (above 3600kW)
100	1 per 100 Wh (up to 3600W)	1 per 100 kWh (up to 3600kWh)	1 per 100 MWh (above 3600kW)
1000	1 per 1000 Wh (up to 3600W)	1 per 1000 kWh (up to 3600kWh)	1 per 1000 MWh (above 3600kW)

Pulse Duration : 60 msec, 100 msec, 200 msec.
 Above options are also applicable to Apparent and Reactive Energy.

Electrical Connections

	Self Powered Aux	External Powered Aux
3 Phase 4 Wire Unbalanced Load		
3 Phase 3 Wire Unbalanced Load	Not Applicable	
1 Phase 2 Wire		

*Note: For Measurement of parameters, Voltage must be present between terminal 2 & 11 for single phase or 3 phase 4 wire network and between terminal 2 & 5 or 2 & 8 for 3 phase 3 wire network.

Rear Connection

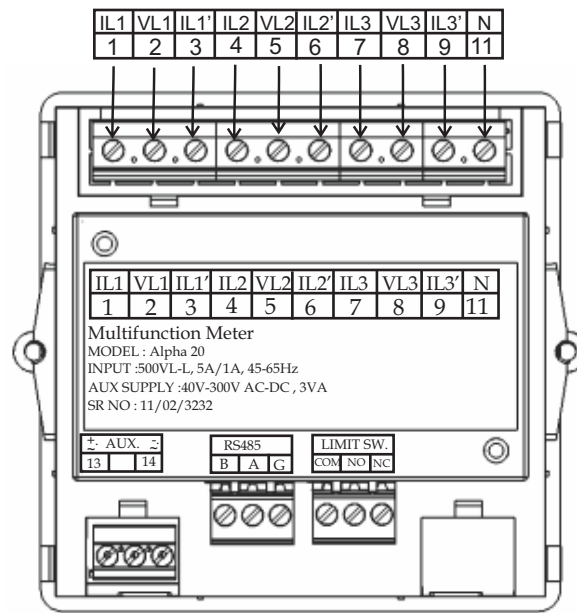

Parameter measurement and Display

Sr No	Parameter	3 Phase 4 Wire	3 Phase 3 Wire	1 Phase 2 Wire
1.	System Volts	✓	✓	✓
2.	System Current	✓	✓	✓
3.	Volts R-N (Phase Voltage for Single phase)	✓	✗	✓
4.	Volts Y-N	✓	✗	✗
5.	Volts B-N	✓	✗	✗
6.	Volts R-Y	✓	✓	✗
7.	Volts Y-B	✓	✓	✗
8.	Volts B-R	✓	✓	✗
9.	Current R (Phase Current for Single phase)	✓	✓	✓
10.	Current Y	✓	✓	✗
11.	Current B	✓	✓	✗
12.	Frequency	✓	✓	✓
13.	System Active Power (kW)	✓	✓	✓
14.	Active Power R (Phase Power for Single phase) (kW)	✓	✗	✓
15.	Active Power Y (kW)	✓	✗	✗
16.	Active Power B (kW)	✓	✗	✗
17.	System Re-active Power (kVAr)	✓	✓	✓
18.	Re-active Power R (Phase Power for Single phase) (kVAr)	✓	✗	✓
19.	Re-active Power Y (kVAr)	✓	✗	✗
20.	Re-active Power B (kVAr)	✓	✗	✗
21.	System Apparent Power (kVA)	✓	✓	✓
22.	Apparent Power R (Phase Power for Single phase) (kVA)	✓	✗	✓
23.	Apparent Power Y (kVA)	✓	✗	✗
24.	Apparent Power B (kVA)	✓	✗	✗
25.	System Phase Angle	✓	✓	✓
26.	System Power Factor	✓	✓	✓
27.	Power Factor R	✓	✗	✓

✓ - Available ✗ - Not available

Parameter measurement and Display

Sr No	Parameter	3 Phase 4 Wire	3 Phase 3 Wire	1 Phase 2 Wire
28.	Power Factor Y	✓	✗	✗
29.	Power Factor B	✓	✗	✗
30.	Phase Angle R	✓	✗	✓
31.	Phase Angle Y	✓	✗	✗
32.	Phase Angle B	✓	✗	✗
33.	Active Energy Import (kWh)	✓	✓	✓
34.	Active Energy Export (kWh)	✓	✓	✓
35.	Reactive Energy Import (kVArh)	✓	✓	✓
36.	Reactive Energy Export (kVArh)	✓	✓	✓
37.	Apparent Energy (kVAh)	✓	✓	✓
38.	RPM	✓	✓	✓
39.	Max (System Voltage / System Current)	✓	✓	✓
40.	Min (System Voltage / System Current)	✓	✓	✓
41.	Hour Run	✓	✓	✓
42.	ON Hour	✓	✓	✓
43.	Number of auxiliary interrupt	✓	✓	✓
44.	Current Demand	✓	✓	✓
45.	kVA Demand	✓	✓	✓
46.	kW Demand Import	✓	✓	✓
47.	kW Demand Export	✓	✓	✓
48.	Max Current Demand	✓	✓	✓
49.	Max kVA Demand	✓	✓	✓
50.	Max kW Demand Import	✓	✓	✓
51.	Max kW Demand Export	✓	✓	✓

✓ - Available ✗ - Not available

Ordering information

Product Code	AP20-	X	X	X	XX	X	X	000000
System Type	3 Ph. (PR. 3W or 4W)	3						
* System Type is Site selectable. ** Select code for factory default setting.	1 Ph.	1						
Input Voltage	100 TO 500VL-L		1					
Input Current	1/5A			1				
Power Supply	Self Aux				SA			
	40 V - 300 U				EA			
	12-48 V DC				LA			
Limit switch	With Limit switch					L		
	Without Limit switch					Z		
RS 485	With RS 485						R	
	Without RS 485						Z	



sifam tinsley
PRECISION INSTRUMENTATION

Sifam Tinsley Instrumentation Inc.
3105, Creekside Village Drive,
Suite No. 801, Kennesaw,
Georgia 30144 (USA)
E-mail Id : psk@sifamtinsley.com
Web : www.sifamtinsley.com
Contact No. : +1 404 736 4903

Sifam Tinsley Instrumentation Ltd
Unit 1 Warner Drive,
Springwood Industrial Estate
Braintree, Essex, UK, CM72YW
E-mail: sales@sifamtinsley.com
Web: www.sifamtinsley.com/uk
Contact: +44(0)1803615139