



1. General :

This Switch complies with international standard IEC 60947-1, IEC 60947-3 & IEC 60947-5.

This product must be used after mounting in panel with hardware supplied, with wires permanently connected to terminals as specified.

2. Meaning of symbols :

- European Conformity Mark

- Switch/Disconnecter Symbol

3. Specification :

Refertechanical data chart.

4. Equipment Installation:

* Due consideration should be given to space behind the cam switch to allow for bends in connecting cables.

* The products do not have internal protection against overload & short circuit, hence external safety protection should be provided. It is recommended to install protective device near a equipment.

*Select mounting location which is protected from water on front and back side of switch.

* Ensure that wires do not remain undertension.

5.Operation & Maintenance:

* Equipment must be installed & maintained by suitably qualified person.

* If equipment is used in a manner not specified by manufacturer, the protection provided by the equipment may be impaired.

* Disconnect supply before installation of Switch and during maintenance.

* Ensure that cables are properly tighten with self lifting screw.

6. Testing :

* Cables should be connected at specified position as shown in connection diagram.

* It is recommended to test the switch before installation as per connection diagram using multimeter.

7. Servicing of Cam Switches :

*Cam switch need not required to be serviced if proper fuse protection and dust protection are provided. How ever if contact failure occurs due to accumulation of dust near contact area, dust can be cleaned by blowing air.

* If contact are slightly welded due to insufficient fuse protection, weld can be opened by forcibly operating the knob to a limited extent.

⚠ NOTICE ⚠

This product has been designed for environment A. Use of this product in environment B may cause unwanted electromagnetic disturbances in which case the user may be required to take adequate mitigation measures.

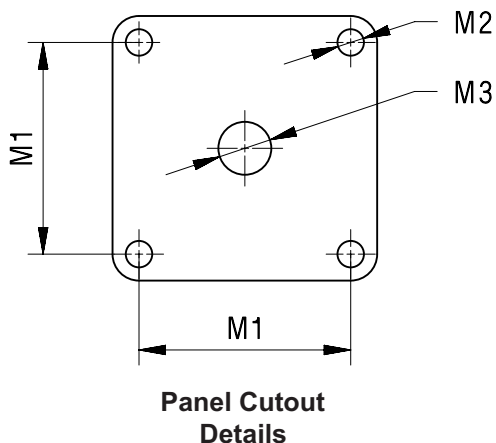
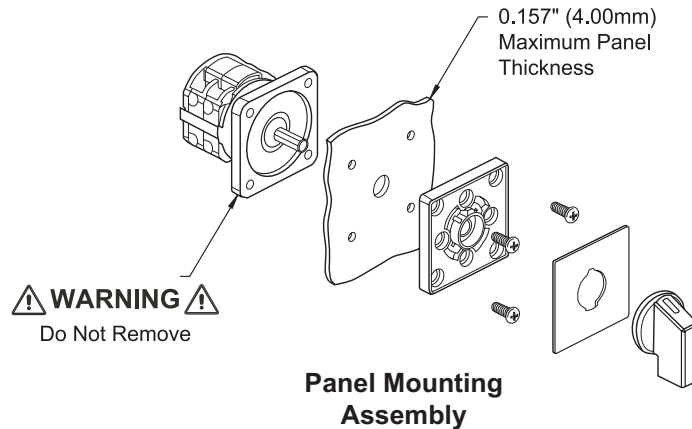

Type	M1	M2	M3
Epsilon 16A	36	4	7
Epsilon 25A	48	4	12











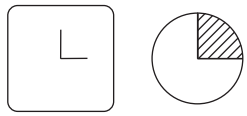



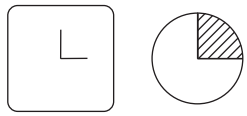



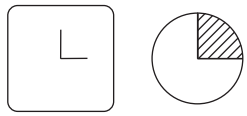



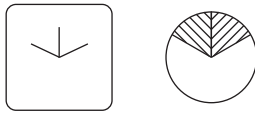





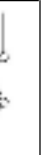
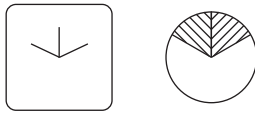





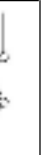
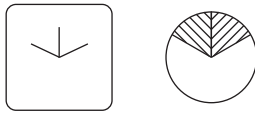





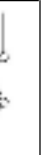
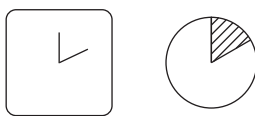



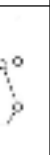

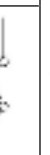
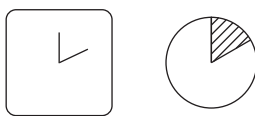

Instruction Manual

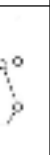
Epsilon Spring Return Switches

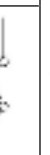
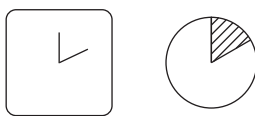
Technical Data

Conformance to standards : European : IEC 60947-1 IEC 60947-3 IEC 60947-5 Indian : IS 13947-1/3/5		Operating Conditions : Frequency : 50/60 Hz Operating Temp. : -25 °C to 60 °C Over voltage category : III Storage : -40°C to 80°C Max. Altitude : 2000 m IP: 50 Front		Switch Life : Mechanical Life : 1 Lac operations @ 300 Cycles/hr Electrical Life : 10,000 operations @ 100% Rated duty at 120 cycles/hr Contacts : Double break type AgNi Double break type AgCdO	
Parameter		Unit	16A	25A	
Rated operational voltage (Ue)		V	690	690	
Rated Insulation voltage (Ui)		V	690	690	
Rated operational current (Ie)		A	16	25	
rated uninterupted current (Ith)		A	20	32	
Rated Impulse withstand voltage (Uimp)		KV	4	6	
Rated short time withstand current (Icw)	(1s- Current)	A	192 *	300	
Rated Fuse short circuit current		KA	5	10	
Fuse size (Type gG /gM)		A	16	25	
AC23A 3phase	220-240V	KW	3	4.7	
	380-440V	KW	5.5	7.5	
	500V	KW	5.5	11	
	660-690V	KW	5.5	11	
AC23A 1phase	110V	KW	0.55	1.5	
	220-240V	KW	1.5	3	
	380-440V	KW	2.2	5.5	
AC3 3phase	220-240V	KW	3	4.7	
	380-440V	KW	5.5	7.5	
	500V	KW	5.5	11	
	600-690V	KW	5.5	11	
AC3 1phase	110V	KW	0.55	1.5	
	220-240V	KW	1.5	3	
	380-440V	KW	2.5	5.5	
AC21A/AC1		A	16	25	
AC15	220-240V	A	5	8	
	380-440V	A	4	5	
Terminal cross -section					
Single / Multiple	Min	mm ²	1.5	2.5	
	Max	mm ²	4	4	
Fine strand with sleeve	Min	mm ²	1	1.5	
	Max	mm ²	2.5	4	
Terminal screw		Metric	M3	M4	
Terminal tightening torque		Nm	0.8	1.2	

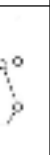
* Rated short time withstand current (0.5s- current)

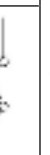
SR. NO.	DESCRIPTION CONNECTION DIAGRAM / TERMINAL MARKING	NO.OF STAGES																																																	
1	Spring Return ON-OFF	1-2																																																	
	<table border="1"> <thead> <tr> <th>OUTPUTSIDE</th> <th>1A</th> <th>1B</th> <th>1C</th> <th>1D</th> </tr> </thead> <tbody> <tr> <td></td> <td></td> <td></td> <td></td> <td></td> </tr> <tr> <th>INPUTSIDE</th> <th>LA</th> <th>LB</th> <th>LC</th> <th>LD</th> </tr> <tr> <th>POLES</th> <td>1</td> <td>2</td> <td>3</td> <td>4</td> </tr> <tr> <th>OFF</th> <td></td> <td></td> <td></td> <td></td> </tr> <tr> <th>ON</th> <td>X</td> <td>X</td> <td>X</td> <td>X</td> </tr> </tbody> </table>		OUTPUTSIDE	1A	1B	1C	1D						INPUTSIDE	LA	LB	LC	LD	POLES	1	2	3	4	OFF					ON	X	X	X	X																			
	OUTPUTSIDE		1A	1B	1C	1D																																													
																																																			
	INPUTSIDE		LA	LB	LC	LD																																													
	POLES		1	2	3	4																																													
	OFF																																																		
ON	X	X	X	X																																															
Offered up to 4 poles																																																			
2	Spring Return Double Throw	1-3																																																	
	<table border="1"> <thead> <tr> <th>OUTPUTSIDE</th> <th>1A</th> <th>2A</th> <th>1B</th> <th>2B</th> <th>1C</th> <th>2C</th> </tr> </thead> <tbody> <tr> <td></td> <td></td> <td></td> <td></td> <td></td> <td></td> <td></td> </tr> <tr> <th>INPUTSIDE</th> <th>LA</th> <th>LA</th> <th>LB</th> <th>LB</th> <th>LC</th> <th>LC</th> </tr> <tr> <th>POLES</th> <td colspan="2">1</td> <td colspan="2">2</td> <td colspan="2">3</td> </tr> <tr> <th>0</th> <td></td> <td></td> <td></td> <td></td> <td></td> <td></td> </tr> <tr> <th>1</th> <td>X</td> <td></td> <td>X</td> <td></td> <td>X</td> <td></td> </tr> <tr> <th>2</th> <td></td> <td>X</td> <td></td> <td>X</td> <td></td> <td>X</td> </tr> </tbody> </table>		OUTPUTSIDE	1A	2A	1B	2B	1C	2C								INPUTSIDE	LA	LA	LB	LB	LC	LC	POLES	1		2		3		0							1	X		X		X		2		X		X		X
	OUTPUTSIDE		1A	2A	1B	2B	1C	2C																																											
																																																			
	INPUTSIDE		LA	LA	LB	LB	LC	LC																																											
	POLES		1		2		3																																												
	0																																																		
1	X		X		X																																														
2		X		X		X																																													
Offered up to 3 poles																																																			
3	Spring Return Changeover without Off	1-3																																																	
	<table border="1"> <thead> <tr> <th>OUTPUTSIDE</th> <th>1A</th> <th>2A</th> <th>1B</th> <th>2B</th> <th>1C</th> <th>2C</th> </tr> </thead> <tbody> <tr> <td></td> <td></td> <td></td> <td></td> <td></td> <td></td> <td></td> </tr> <tr> <th>INPUTSIDE</th> <th>LA</th> <th>LA</th> <th>LB</th> <th>LB</th> <th>LC</th> <th>LC</th> </tr> <tr> <th>POLES</th> <td colspan="2">1</td> <td colspan="2">2</td> <td colspan="2">3</td> </tr> <tr> <th>1</th> <td>X</td> <td></td> <td>X</td> <td></td> <td>X</td> <td></td> </tr> <tr> <th>2</th> <td></td> <td>X</td> <td></td> <td>X</td> <td></td> <td>X</td> </tr> </tbody> </table>		OUTPUTSIDE	1A	2A	1B	2B	1C	2C								INPUTSIDE	LA	LA	LB	LB	LC	LC	POLES	1		2		3		1	X		X		X		2		X		X		X							
	OUTPUTSIDE		1A	2A	1B	2B	1C	2C																																											
																																																			
	INPUTSIDE		LA	LA	LB	LB	LC	LC																																											
	POLES		1		2		3																																												
	1		X		X		X																																												
2		X		X		X																																													
Offered up to 3 poles																																																			

Sifam Tinsley Instrumentation Inc.

3105 Creekside Village Drive, Suite No. 801, Kennesaw, GA 30144 (USA)

Contact No. : +1 404 736 4903

E-mail Id : psk@sifamtinsley.com

Web : www.sifamtinsley.com