



DIGITAL PANEL METER

**N32H**



SERVICE MANUAL



## Contents

|  |    |
|--|----|
| 1 Application.....   | 3  |
| 2 Meter set.....   | 5  |
| 3 Basic requirements, operational safety.....                | 5  |
| 4 Installation.....  | 6  |
| 4.1 Installation method.....                                 | 6  |
| 4.2 External connection diagram.....                         | 7  |
| 5 Service.....   | 10 |
| 5.1 Description of the frontal plate.....                    | 10 |
| 5.2 Buttons' functions.....                                  | 12 |
| 5.3 Programming meter parameters.....                        | 13 |
| 5.3.1 How to change quantity of a selected parameter.....    | 15 |
| 5.3.2 Programmable meter parameters, default parameters..... | 15 |
| 5.4 Meter functions.....                                     | 20 |
| 5.4.1 Measurement.....                                       | 20 |
| 5.4.1.1 Averaging the measuring quantities.....              | 21 |
| 5.4.1.2 Minimum and maximum measuring values.....            | 22 |
| 5.4.1.3 Voltage measurement compensation.....                | 23 |
| 5.4.2 Analog output.....                                     | 23 |
| 5.4.3 Alarm outputs.....                                     | 24 |
| 5.4.4 Binary output.....                                     | 25 |
| 5.5 RS-485 interface.....                                    | 26 |
| 5.5.1 Connection.....  | 26 |
| 5.5.2 Description of the MODBUS protocol implementation..... | 27 |
| 5.5.3 Implemented functions of MODBUS protocol.....          | 28 |
| 5.5.4 Map of the registers.....                              | 28 |
| 5.5.4.1 Registers 4000 – 4054.....                           | 28 |
| 5.5.4.2 Registers 4200 – 4233.....                           | 33 |
| 5.5.4.3 Registers 7500 – 7515 and 7000 – 7031.....           | 35 |
| 5.5.4.4 Registers 7600 – 7677 and 7200 – 7355.....           | 36 |
| 6 Error codes.....   | 37 |
| 7 Technical data.....  | 38 |
| 8 Ordering code.....   | 41 |

# 1 Application

The N32H meter is a digital panel meter adapted to be fixed to the panel. The N32H meters are designed to measure voltages, currents, power, energy and capacity in DC circuits. Current measurement is carried out using an external current shunt, which enables easy adjustment of the current measuring range to the requirements of the application.

Additionally, the meter supports the programmable alarms with the delay activation and deactivation function as well as a memory of the alarm event. The functionality of the meter is complemented by a programmable analog output - RS-485 interface.

The user interface consists four buttons and the high contrast LCD display with backlight. Thanks to the two-line display, it is possible to set the selected unit, display simultaneously the measuring value and the current time, as well as a clear and user friendly menu with simultaneously visible the parameter name and its value.

Features of the N32 meter:

- Wide range of measured voltages.
- Wide range of voltage measurement on the shunt input with automatic selection of the measuring range based on the rated current and rated voltage of the shunt used.
- High sampling frequency of the measuring signals.
- Wide measuring ranges including high peak of the current values and large values of exceeding the measuring range.
- Automatic calculation of the current based on the voltage measurement on the shunt.
- Automatic reset of the energy counter and the capacity counter (accumulated current) after a power decay - a function supporting the measurement of battery charging parameters.
- The function of automatic compensation of the voltage drop on the measuring shunt which helps to correctly measure a voltage, power and energy in relation to the load.
- High contrast LCD display with built-in backlight.
- Two-line display.
- Automatic selection of the unit of the measured (displayed) value.
- Measuring value preview mode.

- Possibility to simultaneously display two selected measured quantities or for example, a measured quantity and a unit or time.
- Programmable display precision with the function of automatic setting of the decimal point and the multiplier (kilo, mega) displayed with the unit.
- Possibility to program the measuring range (narrowing) for the selected displayed value.
- Additional measurement of minimum and maximum values during the moving window, with the possibility of programming one of these values to be displayed as the main one.
- Selection of the period and averaging method with the possibility of synchronizing the average value with the built-in real-time clock.
- Programmable alarms with the functions of programmable delays of alarm activation and deactivation, triggered by a specific controlling value. Up to 4 relays, including up to 3 relays with a switching contact. Possibility to configure each of the alarms to work in a selected mode and to react to any measuring quantity including the current time.
- Possibility to control the alarm outputs (relay) via the RS-485 interface.
- Programmable standard analog outputs enabling the retransmission of a selected measuring quantity or a selected parameter. Freely programmable output type and conversion range.
- Built-in by default RS-485 interface with MODBUS RTU protocol support.
- Built-in real-time clock with a built-in automatic change of DST and inversely. The clock can be a parameter which controls the alarms and the value of the analog output signal.
- Possibility to password protect the settings against unauthorized modification.
- Monitoring of set parameters.
- Programmed averaging time - averaging algorithm in a specified time using standard averaging (determining the number of measurements to be averaged) and averaging based on the moving window algorithm with a given averaging time.
- Signaling of alarm operation by highlighting the number of the active alarm.
- Registration of minimum and maximum measuring values.
- Galvanic separation between the connectors: alarm, measurement, analog outputs auxiliary power outputs, RS-485 interface and power input.
- Protection degree from the front IP65.

- Meter overall dimensions 96 x 48 x 100 (with the terminals).
- The casing is made of a self-extinguishing plastics.
- Wide range of supply voltages.

The view of the N32H meter is shown in Fig. 1.



*Fig. 1: View of the N32H meter.*

## 2 Meter set

The meter set includes:

- Meter N32H – 1 pc
- User's manual – 1 pc
- Clamps to fix in the panel – 4 pcs
- Seal – 1 pc

## 3 Basic requirements, operational safety

In terms of a user safety, the N32H meter meets the requirements of the EN61010-1 standard for the devices intended for use in facilities compliant with the third category of installations.

### ***Comments concerning safety***



- Assembly and installation of the electrical connections should be conducted only by a person authorized and certificated to perform assembly of electric devices .
- Always check the connections before turning the meter on.
- The meter is designed for installation and usage in the industrial electromagnetic environment.

- A switch or a circuit-breaker should be installed in the building or facility. The switch should be located near the device, easily accessible by the operator and suitably marked.
- Removal of the meter electronics during the warranty period voids the warranty.

## 4 Installation

### 4.1 Installation method

The N32H meters are designed to be mounted in a panel. Prior to installation a  $92^{+0.6} \times 45^{+0.6}$  mm slot must be made in the panel. The maximum thickness of the panel material cannot exceed 6 mm. The meter should be mounted from the front of the panel with disconnected meter connection strips.

Before inserting the meter into the panel check the correct position of the meter seal and make sure that the edges of the panel are not sharp what could damage the seal. After inserting the meter into the slot, mount it with the mounting brackets provided in the meter set (Fig. 2).

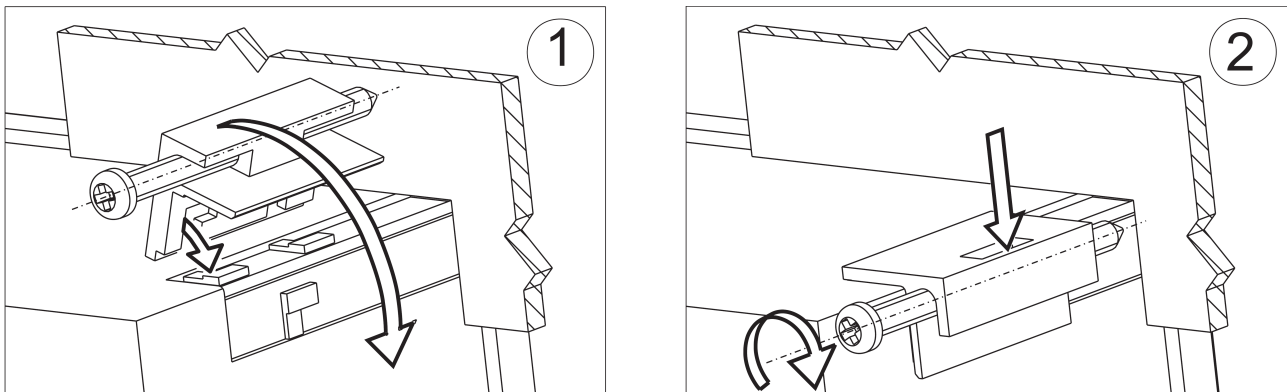

Fig. 2: Meter fixing.

Electrical connections of the meter should be made with the wires with the cross-section up to  $2.5 \text{ mm}^2$ . Detachable sockets with the plugs of 5.08 mm pitch can be used for the connections.

The external dimensions of the meter are shown in Fig. 3.

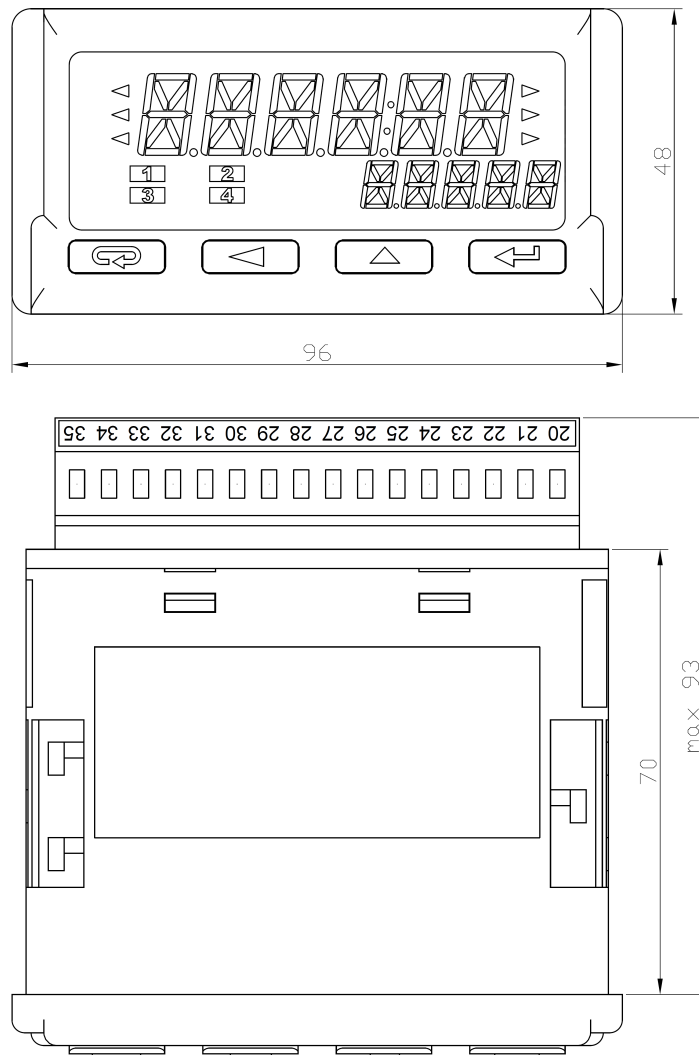

Fig. 3: Meter overall dimensions.

### 4.2 External connection diagram

The N32H meter has two detachable terminal strips to connect the wires of a cross-section up to 2.5 mm<sup>2</sup>. The view of the meter from the connectors' side is shown in Fig. 5. The upper terminal strip is optional and depends on the accessories of the meter.

The circuits of successive groups of the terminals are separated from each other, as shown in Fig. 4.



Fig. 4: Galvanic isolation of the N32H meter.

**Note: Unused terminals of the terminal strips (NC) must not be connected to any signals.**

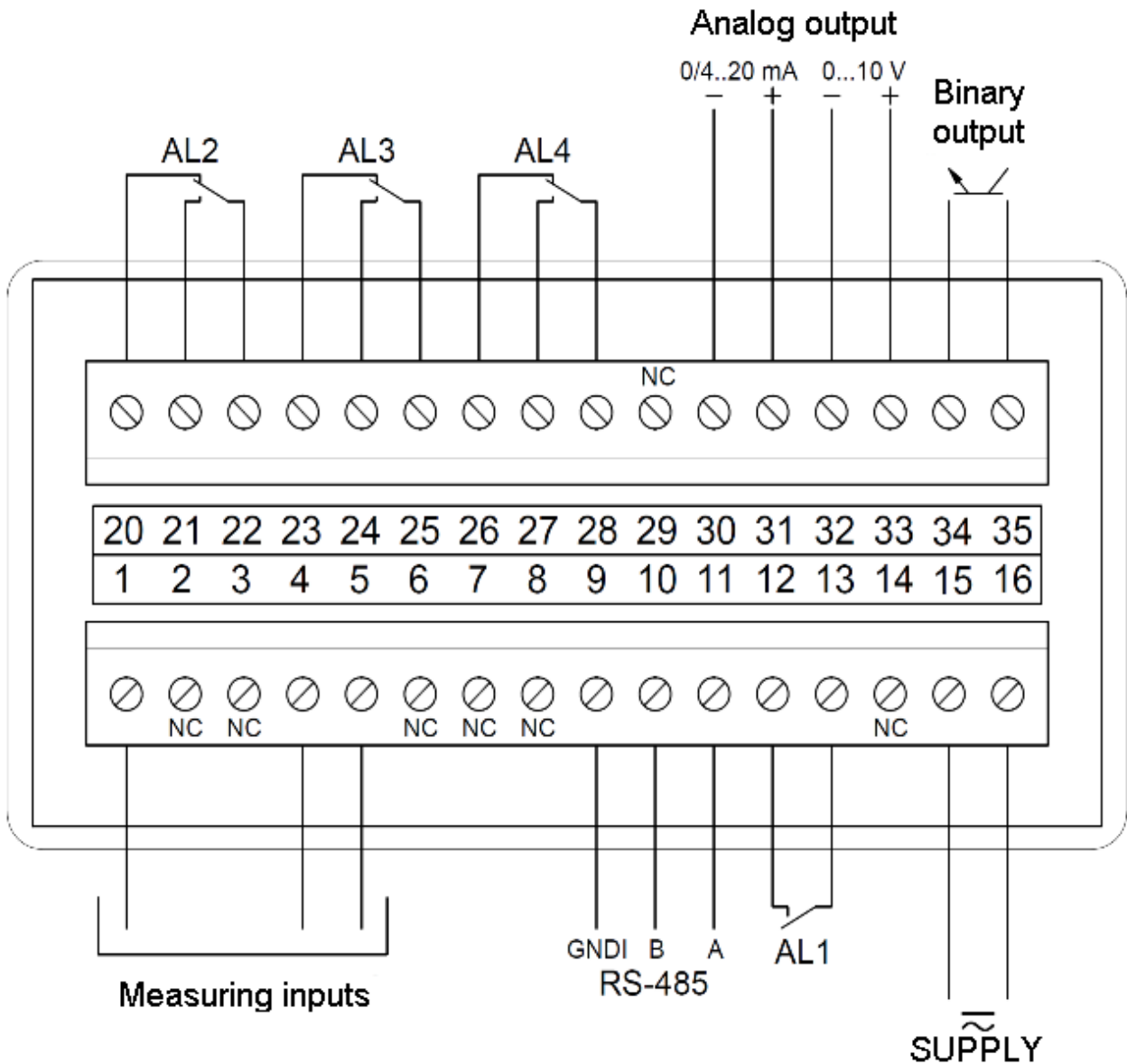

Fig. 5: Signals on the terminal strips.

Detailed description of the signals is shown in the table below, and the connection of the measuring signals is shown in Fig. 6.

| Terminal  | Function         | Description  |
|-----------|------------------|--|
| 1, 4, 5   | Measuring inputs | Measuring inputs for connecting the measured voltage and a shunt for current measurement. Examples of the connections are shown in Fig. 6. |
| 9, 10, 11 | RS-485           | RS-485 interface signals   |
| 12, 13    | Alarm 1          | Alarm output 1, which is NO relay contact.   |
| 15, 16    | Power supply     | Meter power supply connection. Range of supply voltages supported by the meter depends on the ordering code. It                            |



|           |                           |  |
|-----------|---------------------------|--|
|           |                           | is required to check if the rated range of the meter corresponds to the installation to which the meter will be connected before installing the meter.   |
| 20...28   | Alarms 2, 3, 4 (optional) | The alarm outputs 2, 3 and 4 use a relay with a switching contact.   |
| 30...34   | Analog output             | Analog output. The output must be properly connected according to the type of output selected in the configuration (voltage or current): the terminals 30 and 31 for the current output or the terminals 32 and 33 for the voltage output. It is not possible to use the voltage and current outputs at the same time - the correct value in accordance with the configuration, will be available only for the selected output type. |
| 35, 36    | Binary output             | Open collector binary output. Energy counter pulse output.   |
| 8, 14, 29 | NC                        | Unused terminals. Should be left unconnected.  |

The connection of the basic measured signals is shown below. The N32H meter can also be used to measure only voltage or only current.

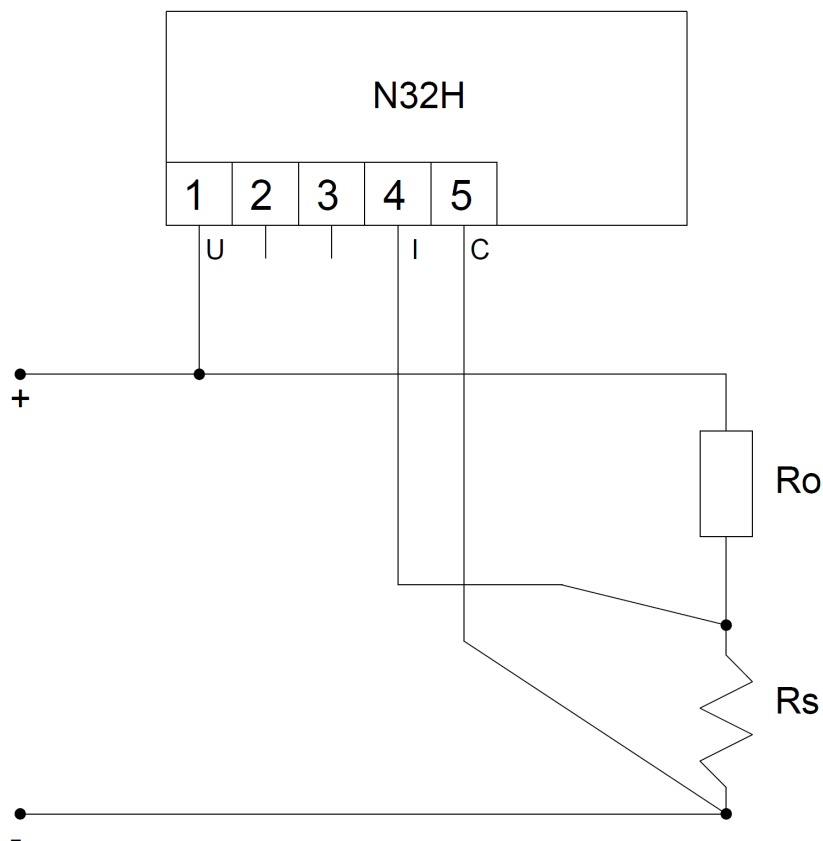

Fig. 6: Connection of the N32H meter,

Symbols shown in the diagram:

N32H meter:

- U - voltage measurement terminal. The voltage is measured between the U-C terminals.
- I - voltage measurement input from the shunt - indirect current measurement method.
- C - common terminal, a ground of the measuring system.

Other elements in the diagram:

- Ro - load, energy consumer.
- Rs - shunt or measuring resistor.

NOTE: The terminals I and C should be connected directly to the voltage measurement terminals on the shunt so that the resistance of the circuit leads does not cause an error in the current measurement. The resistance of the circuit leads can be much bigger than a shunt resistance!

## 5 Service

The N32 meter user interface includes an LCD display and the buttons which enable to display the measuring value, a full configuration and setting of the meter or modification of the parameters.

After turning the meter on the display shows the name of the meter and the software version. If there is no error during meter initialization process, the meter will switch to displaying the measuring value. If during the initialization any irregularities or deviations are detected, than a message with information about a detected error will be displayed (see point 6 - Error codes).

### 5.1 Description of the frontal plate

View of the front panel of the meter is shown in Fig. 6. The LCD display with backlight and 4 buttons are on the front panel. The description of the display fields is shown below. The button functions are shown in the section 5.2.

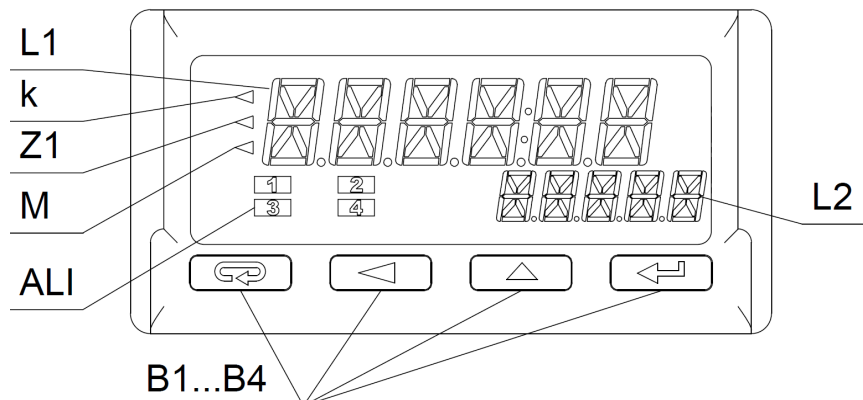





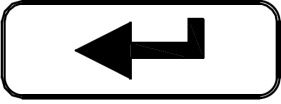





Fig. 7: Front panel of the meter.

| Designation | Description   |
|-------------|---|
| L1          | The upper (main) line of the display has 6 characters used to display a measuring value or a parameter value during the meter configuration.  |
| L2          | The lower (auxiliary) line of the display has 5 characters used to display a measuring value, not converted by the individual characteristic or, according to configuration, a unit or current time.  |
| k           | The kilo symbol means that the displayed value is divided by a thousand, e.g. when the setting is displayed, the illuminated symbol means that the given value is a thousand times greater. For example, 1.2 kA means 1200 A.   |
| Z1          | Measuring value averaging indicator. Illuminated averaging indicator informs that the set measuring value averaging period has not elapsed yet.   |
| M           | The mega symbol means that the displayed value is divided by a million, e.g. when the setting is displayed, the illuminated symbol means that the given value is a million times greater. For example, 3.5 MW means 3,500,000 W.  |
| ALI         | Alarm status field. This field contains the indicator informing about the alarm status. Illuminated alarm indicator means that an alarm event is in progress and the relay corresponding to the alarm is activated. Flashing symbol means that the alarm state is saved (if the alarm memory is activated). |
| B1...B4     | Meter operation buttons. The description of the button functions and their various combinations are shown in section 5.2.   |

The lower line of the display can be configured to display the unit, where the unit is automatically adapted to the displayed value of measured quantity and depends on set indication range. For example, if a shunt with a rated range greater than 1000 A is connected, the current will be displayed in kilo amperes (kA).

Additionally, the lower line can display a selected value of measured quantity (measured or calculated quantities) or the current time.

## 5.2 Buttons' functions

|   |   |
|---|---|
|    | <p><b>Cancel button:</b></p> <ul style="list-style-type: none"> <li>• Exiting the menu and exit to the main screen.</li> <li>• Exiting a lower level of the menu and return to a higher level.</li> <li>• Canceling changing the set value (when editing the parameter value)</li> <li>• Entering the measuring value preview mode - hold down the button for at least 3 seconds.</li> </ul>  |
|    | <p><b>Digit change button:</b></p> <ul style="list-style-type: none"> <li>• Navigating the menu - decreasing the items of the menu.</li> <li>• Decreasing the controlled quantity while editing a parameter and setting selection from the list of settings, e.g. alarm type.</li> <li>• Changing the controlled digit when setting numerical parameters.</li> <li>• Pressing the button during a normal operation displays a minimum value for 2 seconds, then the display returns to displaying a measuring value.</li> </ul> |
|  | <p><b>Increase value button:</b></p> <ul style="list-style-type: none"> <li>• Navigating the menu - increasing the items of the menu.</li> <li>• Increasing the value of the selected parameter or increasing the value of a digit when changing the numerical value.</li> <li>• Pressing the button during a normal operation displays a maximum value for 2 seconds, then the display returns to displaying a measuring value.</li> </ul>   |
|  | <p><b>Confirm button:</b></p> <ul style="list-style-type: none"> <li>• Entering the programming mode (holding down the button for at least 3 seconds).</li> <li>• Navigating the menu - entering the parameter value editing mode or entering the selected lower level of the menu.</li> <li>• Accepting the changed parameter value.</li> <li>• Viewing the measuring values in the preview mode.</li> </ul>   |
|  | <p>Deleting minimum value. DELMIN message is displayed after deleting. To avoid accidentally exit the menu in the preview mode, it is recommended to press first the button , and then the button  and holding them until DELMIN message is displayed.</p>   |
|  | <p>Deleting maximum value. DELMAX message is displayed after deleting. To avoid accidentally exit the menu in the preview mode, it is recommended to press first the button , and then the button  and holding them until DELMIN message is displayed.</p>  |

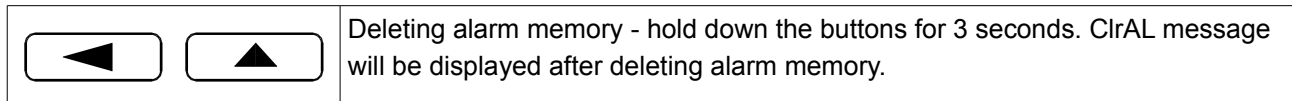

All the events of deleting of saved minimum, maximum values and alarm activation memory are indicated by the meter by displaying an appropriate message.

### 5.3 Programming meter parameters

Programming meter parameters is possible via the RS485 interface and by direct edition of the parameters using the buttons and the meter display.

Direct programming process is easy thanks to meter menu, which includes the settings grouped into sections with all parameters related to a given functionality, e.g. all parameters of the serial interface are grouped in the menu **RS485**.

Pressing and holding the confirm button for at least 3 seconds allows to switch from a normal operation to meter menu . If access to change the parameters is password protected, the user will be requested to enter the access password before entering the menu. Entering an incorrect password will allow to enter the menu but it will be not possible to change the parameters - parameters monitoring mode. Entering a correct password will allow to move to a programming matrix, the menu after entering the programming mode is shown below.



























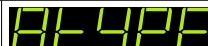















Fig. 8: View of meter menu.







While navigating the meter main menu with the groups of the parameters, the upper line of the display shows the name of the group and the lower line continuously displays the word MENU. After entering the group of the parameters (after pressing the confirm button), the upper line displays the value of a given setting and the lower line shows the name of the parameter which value is displayed in the upper line. Sample view of the selection of the measured input signal type is shown in Fig. 9.







Fig. 9: View of menu when setting a parameter.



The buttons   allow to navigate the menu of the meter. After selecting the group of the parameters which configuration is to be changed, press the confirm button to move to the parameters of the group. The parameter which value is to be modified is selected the same way as the selection of the group. To cancel the parameter change, press the cancel button  to exit the parameter changing mode or the parameter group. The meter will automatically exit the programming mode and return to displaying the measuring value if no button is pressed for 30 seconds during programming. The programming matrix is shown below.

|   |   |  |   |  |   |
|---|---|--|---|--|---|
|    | <br>Voltage measuring range selection.                       | <br>Shunt rated current range.  | <br>Shunt rated voltage at a rated current.  | <br>Single measurement time as a multiple of 100 milliseconds.   | <br>Selection of measuring quantities values averaging method (standard or moving window method).    |
|   | <br>Measuring quantities values averaging period in minutes. | <br>Averaging synchronization with the time clock.  | <br>Voltage measurement compensation (includes voltage drop on a shunt).   | <br>Automatic reset of the energy and capacity meter after power recovery.   | <br>Initial value of the energy counter after a counter reset.                                       |
|   | <br>Pulse weight on a binary output.                       | <br>Reset (enter initial value) energy counter.   | <br>Reset capacity counter.  |  |   |
|  | <br>Selection of main displayed value.                     | <br>Minimum value on the display. For values lower than this value, a lower overrun message is displayed. | <br>Maximum value on the display. For values higher than this value, an upper overrun message is displayed.                        | <br>Resolution - position of the decimal point.  | <br>Function of a lower line of the display - selection of a quantity displayed in the lower line. |
|  | <br>Selection of quantity controlling the alarm state.     | <br>Selection of alarm type.  | <br>Alarm state change lower threshold.  | <br>Alarm state change upper threshold.  | <br>Alarm activation delay.  |
|   | <br>Alarm deactivation delay.                              | <br>Active alarm memory.  |   |  |   |
|  | <br>Meter network address.                                 | <br>Transmission frame type - data format.  | <br>Baud rate.   |  |   |
|  | <br>Selection of the type of analog output used.           | <br>Selection of value controlling the analog output.   | <br>Value of the controlling quantity for which the output will have a minimum value, in accordance with the selected output type. | <br>Value of the controlling quantity for which the output will have a rated value, in accordance with the selected output type. | <br>Value on the analog output in case of an error on the measuring input.                         |





|   |  |  |  |   |   |
|---|--|--|--|---|---|
|  | <br>Current time according to the internal clock. | <br>Current date according to the internal clock. | <br>Automatic change of DST and inversely | <br>Password to protect against settings modification. | <br>Restore default settings |
|---|--|--|--|---|---|

### 5.3.1 How to change quantity of a selected parameter

To increase the value of the selected parameter, press the button . Pressing the button will increase the currently set digit by 1 and after reaching the value 9, pressing the button will set the value 0. After setting the required value of a digit, move to the next digit by pressing the button . After setting the required parameter value, press the confirm button  to accept the entered value or the cancel button  to cancel the parameter change and return to the previous value of the parameter. It is possible to change a sign of the entered value during setting the last digit (most significant).

There are three steps to change the floating point values. The first step is to set the digits and a sign in accordance with the algorithm described above. The second step is set the position of the decimal point after pressing the confirm button. The buttons   are used to set the position of the decimal point. After setting the decimal point position as required, press the confirm button to move to the third step - setting the multiplier of kilo, mega or no multiplier. Symbol of the multiplier value is shown on the left side of the display.

Entering an incorrect value of a given parameter causes that the new value is not accepted and the parameter will automatically have the previous value.

To change the parameters other than numerical select the appropriate setting from the parameter list using the buttons  . After selecting the appropriate setting, press the confirm button  to download the setting or the cancel button  to return to the previous value and exit the parameter change mode.

### 5.3.2 Programmable meter parameters, default parameters

The N32H meters have a number of programmable parameters, which enable the meter to be adapted to the requirements of application. The parameters grouped according to the menu are shown in the tables below.

Table 1

| <b>INPLU</b>     |   |   |
|------------------|---|---|
| Parameter symbol | Description   | Range of changes  |
| <b>V RANGE</b>   | Voltage measurement range in voltage measurement loop   | <b>Default: 50V</b><br><b>50V</b> – rated measurement range 50 V<br><b>100V</b> – rated measurement range 100 V<br><b>150V</b> – rated measurement range 150 V<br><b>300V</b> – rated measurement range 300 V<br><b>600V</b> – rated measurement range 600 V  |
| <b>I NOM</b>     | Rated current of the connected shunt in amperes   | <b>Default: 100</b><br>1...60000  |
| <b>U NOM</b>     | Rated voltage of the connected shunt in mV.   | <b>Default: 60</b><br>30...1500   |
| <b>SAMPLE</b>    | Time of a single measurement as a multiple of 100 ms  | <b>Default : 10</b><br>1...600  |
| <b>AVGCLY</b>    | Method of calculating the average value   | <b>Default: MOVING</b><br><b>MOVING</b> – the average values of voltage, current and power are calculated based on a moving window method, where the average value is updated after each measurement. Note: The average value can be updated every few measurements in case of long averaging times or short measurement time, due to the length of the measurement table with maximum of 1800 elements.<br><b>StAnd</b> – the average value is calculated after each lapse of set averaging time. The previous average value (for the previous period) is displayed until the averaging time is completed. |
| <b>AVGPE</b>     | Averaging period of the measured voltage, current and power values in minutes.                  | <b>Default: 15</b><br>1...60  |
| <b>RECS</b>      | Synchronization of counting the average value with the internal time clock.                     | <b>Default: OFF</b><br><b>OFF</b> – Synchronization is disabled.<br><b>ON</b> – Synchronization internal real time clock is enabled. This setting takes effect only if the set averaging period is 60 minutes divider, e.g. 10, 15, 20, etc.  |
| <b>U CMP</b>     | Voltage compensation of voltage drop on a shunt   | <b>Default: OFF</b><br><b>OFF</b> – Compensation is disabled. The voltage measuring value is the voltage between the terminals U and C.<br><b>ON</b> – Compensation is enabled. The value of the measured voltage between the terminals U and C is reduced by the value of the voltage drop on a shunt, and this task is done for each sample of the measured voltage and current, also affects the power and energy measurement. The measurement of voltage, power and energy in relation to the power delivered to the load is correct thanks to enabled compensation.                                    |
| <b>AE RST</b>    | Automatic reset (setting) of the energy counter and the capacity counter (accumulated current). | <b>Default: OFF</b><br><b>OFF</b> – Automatic reset of counters is disabled.<br><b>ON</b> – Automatic reset (setting) of the energy counter and reset of the capacity counter is enabled. If the absolute value of the measured current is lower than 0.5% of the rated current range for at least 500 ms, and then exceeds this threshold, then the energy counter is reset (set) and the capacity counter is reset.   |
| <b>ER VAL</b>    | Initial value of the energy counter. The value is assigned to the energy counter during a       | <b>Default: 0</b>   |













|   |   |  |
|---|---|--|
|   | reset/setting the counter.  | -99999M...999999M  |
|  | Pulse weight in kWh, portion of an energy corresponding to one pulse on the binary output.<br>The EP W value determines at what change of the energy counter one pulse will be assigned to the binary output. | <b>Default: 1</b><br>0.001...999999 [kWh]  |
|  | Reset / set energy counter  | <b>Default : OFF</b><br><b>OFF</b> – Do nothing<br><b>ON</b> – Reset a counter. The parameter is automatically set to the value OFF after reset of the counter (setting the value from the ERVAL parameter); |
|  | Reset accumulated current counter (capacity)  | <b>Default: OFF</b><br><b>OFF</b> – Do nothing<br><b>ON</b> – Reset a counter. The parameter is automatically set to the value OFF after reset of the counter;   |

Table 2

|    |  |   |
|---|--|---|
| Parameter symbol  | Description  | Range of changes  |
|  | Selection of the main value displayed on the top line of the display.  | <b>Default: U</b><br>U – currently measured voltage value.<br>I – currently measured current value.<br>P – currently measured power value.<br>E – energy counter value.<br>CAP – accumulated current counter value (capacity).<br>AVG U – voltage mean value in a given averaging period.<br>AVG I – current mean value in a given averaging period.<br>AVG P – power mean value in a given averaging period.<br>MIN U – voltage minimum value in a given averaging period.<br>MAX U – voltage maximum value in a given averaging period.<br>MIN I – current minimum value in a given averaging period.<br>MAX I – current maximum value in a given averaging period.<br>MIN P – power minimum value in a given averaging period.<br>MAX P – power minimum value in a given averaging period.<br><b>Note:</b> The averaging period is defined by AVGPE setting. |
|  | Display narrowing lower threshold. If the value to be displayed is below the threshold, the lower limit symbol is displayed<br> | <b>Default: -99999</b><br>-99999M...999999M   |
|  | Display narrowing upper threshold. If the value to be displayed is above the threshold, the upper limit symbol is displayed<br> | <b>Default: -99999</b><br>-99999M...999999M   |
|  | Resolution, display format as the position of the decimal point.   | <b>Default: 0000.00</b><br>000000<br>00000.0<br>0000.00<br>000.000<br>00.0000<br>0.00000<br>AUTO – automatic position of the decimal point for maximum possible resolution.   |
|  | Selection of the parameter displayed in the lower line of the display.   | <b>Default: UNIt</b><br>UNIt – unit<br>U – currently measured voltage value.<br>I – currently measured current value.<br>P – currently measured power value.  |

|  |  |  |
|--|--|--|
|  |  | <p>E – energy counter value.<br/> <b>CAP</b> – accumulated current counter value (capacity).<br/> <b>AVG U</b> – voltage mean value in a given averaging period.<br/> <b>AVG I</b> – current mean value in a given averaging period.<br/> <b>AVG P</b> – power mean value in a given averaging period.<br/> <b>MIN U</b> – voltage minimum value in a given averaging period.<br/> <b>MAX U</b> – voltage maximum value in a given averaging period.<br/> <b>MIN I</b> – current minimum value in a given averaging period.<br/> <b>MAX I</b> – current maximum value in a given averaging period.<br/> <b>MIN P</b> – power minimum value in a given averaging period.<br/> <b>MAX P</b> – power maximum value in a given averaging period.<br/> <b>clock</b> – current time.</p> <p><b>Note:</b> The averaging period is defined by AVGPE setting.</p> |
|--|--|--|

**Table 3**









| <b>ALARM1, ALARM2, ALARM3, ALARM4</b>   |  |  |
|---|--|--|
| Parameter symbol  | Description  | Range of changes   |
|  | Input value controlling the alarm.   | <p><b>Default: U</b></p> <p>U – currently measured voltage value.<br/>                     I – currently measured current value.<br/>                     P – currently measured power value.<br/> <b>AVG U</b> – voltage mean value in a given averaging period.<br/> <b>AVG I</b> – current mean value in a given averaging period.<br/> <b>AVG P</b> – power mean value in a given averaging period.<br/>                     E – energy counter value.<br/> <b>CAP</b> – accumulated current counter value (capacity).<br/> <b>tIME</b> – current time based on the internal time clock.</p> <p><b>Note:</b> The averaging period is defined by AVGPE setting.</p> |
|  | Alarm type (see section 5.4.3)   | <p><b>Default: H-oFF</b></p> <p>n-on – normally enabled<br/>                     n-oFF – normally disabled<br/>                     on – enabled<br/>                     oFF – disabled<br/>                     H-on – permanently enabled (manually)<br/>                     H-oFF – permanently disabled (manually)<br/>                     REG – the state controlled by the MODBUS protocol register.</p>  |
|  | Alarm state change lower threshold.  | <p><b>Default: 10</b><br/>                     -99999...999999</p>   |
|  | Alarm state change upper threshold.  | <p><b>Default: 20</b><br/>                     -99999...999999</p>   |
|  | Alarm activation delay - the duration in seconds of the alarm state before activating the alarm relay.   | <p><b>Default: 0</b><br/>                     0...900</p>  |
|  | Alarm deactivation delay - the duration in seconds the state without the alarm before deactivating the alarm relay.  | <p><b>Default: 10</b><br/>                     0...900</p>   |
|  | Alarm signalization latch. When the function is enabled, after the alarm event ends, the display indicator informing about the alarm status will be flashing signaling the alarm until it is canceled by a combination of buttons   or via the RS-485 interface. | <p><b>Default: OFF</b></p> <p>ON – alarm memory is activated.<br/>                     OFF – alarm memory is deactivated.</p>  |

Table 4

| <b>RS485</b>     |   |   |
|------------------|---|---|
| Parameter symbol | Description   | Range of changes  |
| <b>Addr</b>      | MODBUS network meter address  | <b>Default: 1</b><br>1...247  |
| <b>Mode</b>      | The transmission frame type of RS-485 interface. Setting the parity bits and the number of stop bits. | <b>Default: F8N1</b><br>F8N1<br>F8N2<br>F8O1<br>F8E1  |
| <b>Baud</b>      | RS-485 interface baud rate.   | <b>Default: 9.6k</b><br>2.4k – 2400 b/s<br>4.8k – 4800 b/s<br>9.6k – 9600 b/s<br>14.4k – 14400 b/s<br>19.2k – 19200 b/s<br>28.8k – 28800 b/s<br>38.4k – 38400 b/s<br>57.6k – 57600 b/s<br>115.2k – 115200 b/s |

Table 5

| <b>AnOut</b>     |   |  |
|------------------|---|--|
| Parameter symbol | Description   | Range of changes   |
| <b>ATYPE</b>     | Selection of the operating mode and the type of analog output used with the option of switching off the output and manual setting the output value. | <b>Default: OFF</b><br>OFF – Output support is disabled.<br>4 20MA – current output 4...20 mA.<br>0 20MA – current output 0...20 mA.<br>0 10V – voltage output 0...10 V.<br>MAN I – current output. The output value corresponds to the AnMAN setting.<br>MAN U – voltage output. The output value corresponds to the AnMAN setting.   |
| <b>INPV</b>      | Input quantity controlling the analog output  | <b>Default: U</b><br>U – currently measured voltage value.<br>I – currently measured current value.<br>P – currently measured power value.<br>AVG U – voltage mean value in a given averaging period.<br>AVG I – current mean value in a given averaging period.<br>AVG P – power mean value in a given averaging period.<br>E – energy counter value.<br>CAP – accumulated current counter value (capacity).<br>tIME – current time based on the internal time clock.<br><b>Note:</b> The averaging period is defined by AVGPE setting. |
| <b>AnLo</b>      | Displayed (measured) value for which the analog output will have a rated minimum value, in accordance with the programmed output type.              | <b>Default: 0</b><br>-99999M...999999M   |
| <b>AnHi</b>      | Displayed (measured) value for which the analog output will have a rated maximum value, in accordance with the programmed output type.              | <b>Default: 100</b><br>-99999M...999999M   |
| <b>AnMAN</b>     | Value of the signal on the analog output for output value manual control.<br>Note: The value is set on the analog output                            | <b>Default: 0</b><br>0...22  |

|  |  |  |
|--|--|--|
|  | after detecting an error on the measuring input. The maximum possible signal will be generated if the value exceeds the maximum value for a given output type. |  |
|--|--|--|

Table 6

| <b>SYSTEM</b>    |  |   |
|------------------|--|---|
| Parameter symbol | Description  | Range of changes  |
| <b>TIME</b>      | Setting the current time. Confirmation of the time resets the seconds counter.   | <b>Default: (not applicable)</b><br>00:2359   |
| <b>DATE</b>      | Setting the current date in YYYY.MM.DD format, where:<br>YY – year.<br>MM – month.<br>DD – day of the month.   | <b>Default : (not applicable)</b><br>00.01.01...99.12.31  |
| <b>Auto</b>      | Automatic change of DST and inversely  | <b>Default: OFF</b><br><b>OFF</b> – automatic time change disabled.<br><b>ON</b> – automatic time change enabled. |
| <b>PASS</b>      | Password to access the meter configuration. When the set value is different from zero, each attempt to enter the menu of the meter will require entering a password. In case of providing an incorrect password, it will be possible to enter the menu in the monitoring mode without a possibility of make any changes. | <b>Default: 0</b><br>0...9999   |
| <b>FACT</b>      | Restore default settings. Selecting YES setting will restore all settings to the default settings and set FACT setting to NO.  | <b>Default: NO</b><br>NO – do nothing.<br>YES – restore default settings (factory).                               |

## 5.4 Meter functions

### 5.4.1 Measurement

The N32H meters continuously measure a voltage (rated) and a current (rated) and based on these measurements calculate the power value (TRUE RMS value), energy (calculated based on instantaneous values of power) and the value of accumulated current (capacity), which quantifies the amount of charge transferred in Ah. The value of the capacity counter can be used to measure the transferred charge, e.g. for battery charging.



**Note:** The value of power the RMS value calculated as the sum of the products of voltage and current samples (it may have a different value than the product of the current and voltage rated values).

The measurements are done with 8000 measurements per second, and then averaged over a defined 100 ms period. The user can define the duration of the measurement time by providing the number of 100 ms periods of measurement. By default, the measurement time is defined as 10 basic measurements, i.e. one second. When changing the measurement time, it needs to be considered that the shorter the measurement time, the greater the influence of noise on the measuring value, and therefore the lower the stability of indications.

The measuring values are continuously analyzed during averaging, and additionally, the minimum and maximum measuring values are determined during the averaging period, as well as the total minimum and maximum measuring values, which are saved in the non-volatile memory of the meter.

All measuring parameters are available via the RS-485 interface, including the basic measuring values e.g. voltage on the shunt.

The main displayed value can be limited by the user by specifying the minimum and maximum displayed value. Exceeding set lower threshold of the measurement (the measuring value lower than the set limit value) causes to display information about exceeding the lower limit, and exceeding set upper threshold of the measuring range (measuring value greater than the set limit value) causes to display information about exceeding the upper limit.

All the values of measuring quantities are available through the RS-485 interface and at the parameter preview level. Entry a measuring value preview mode can be done by pressing for at least 3 seconds the cancel button . The currently displayed value can be changed by pressing the confirm button . When previewing the measuring values, its value is displayed in the upper line and the lower line alternately displays the parameter name and its unit. Additionally, it is possible in the value preview mode to check the minimum and maximum values of a given quantity, and to delete them (see section 5.4.1.2). The meter will return to the normal operation if no button is pressed for 30 seconds (the main displayed value defined in the configuration will be displayed).



#### **5.4.1.1 Averaging the measuring quantities**

The measuring values are averaged in two stage process. The first stage of averaging - the arithmetic mean is calculated from the indicated number of measurements defined by SAVGt parameter. The parameter also determines the time of a single measurement - one measurement takes 100 ms of time, then for the SAVG parameter set to 10, the time of a single measurement will be one second. There is a single measurement that represents the current measuring value after the first stage of averaging.

Additionally, the average value is calculated for each of the measuring parameters (U, I, P), and the averaging period is defined by the user by defining AVGPE parameter in minutes. The average value can additionally be synchronized with the internal time clock. The method of calculating the average value is defined by the user - AVGtY parameter, which can be selected from the standard averaging method, where the new average value is calculated after the averaging time has finished, or the moving window method, where the average value is calculated continuously from a selected period of time, e.g. for the setting of 15 minutes, the average value represents the average value over the last 15 minutes and is continuously updated. In the given example, if the synchronization is enabled, the average value is calculated from every quarter of an hour, i.e. the minutes of the clock 0, 15, 30, 45 indicate a new averaging period.

The buffers for average value calculation have a length of 1800 single measurements, and each of the averaged values has a separate data buffer, therefore the average value calculated by the moving window method can be updated less frequently than it would result from the time of a single measurement. For example, for the averaging period of 60 minutes and a single measurement time of 1 second, the average value will be updated every 2 seconds because in this case the buffer length would have to be 3600 measurements. For the buffer with a length of 1800 measurements, each element in this case contains a value of averaging two individual measurements.

#### 5.4.1.2 Minimum and maximum measuring values

The N32 meter continuously measures the signal on the measuring inputs and calculates the derived parameters, e.g. power. The measuring values are constantly monitored, if the measuring range is not exceeded during the measurement. If any of the values is smaller than the current minimal value of a given parameter, then the new minimal value is saved. When the measuring (displayed) value is higher than the current maximum value of a given parameter, then the new maximum value is saved. The minimum and maximum values are available via the interface and from the panel of the meter. Press the button  to display the minimum value of the main displayed value. Press the button  to display the maximum value. The minimum / maximum value is displayed for 2 seconds, then the meter automatically returns to displaying the measuring value.









Reset of the minimum / maximum value can be done via the interface or directly using the meter keypad. Press a combination of buttons   to reset the minimum value, and press a combination of buttons   to reset the maximum value. Each reset of the minimum or maximum value using the buttons is confirmed by a message - an example the message is shown below.



Fig. 10: The message after resetting the maximum value.

To display the minimum and maximum value of the parameters which are not displayed continuously on the display is possible from the measuring value preview menu - to access the menu press and hold the cancel button  for at least 3 seconds. Changing the currently indicated quantity after entering the preview menu can be done by pressing the confirm button . The minimum and maximum value for a given parameter can be displayed or deleted in the same way as the main displayed value, but to avoid accidentally exit the menu, it is recommended to press one of the buttons first  , and then the button .

### 5.4.1.3 Voltage measurement compensation

The N32H meters support the voltage measurement compensation, which is disabled by default and can be enabled by the user (U CMP parameter).

Voltage measurement compensation includes the voltage drop on a shunt during voltage and power measurement and is used in the systems which require precise measurement of power delivered to the receiver, and not the imported power. It is important to measure the voltage directly on the load when using the compensation method, and connect the current measurement shunt to the load using the shortest possible wires to avoid significant voltage drops (they should be much smaller than the voltage drop on the shunt).

The compensation for each voltage and current sample reduces the measuring voltage value by the value of the voltage drop on a shunt.

### 5.4.2 Analog output

The N32H meters can have one analog output (depends on the ordering code) connected to the meter terminals as a voltage output (0...10 V output) and as a current output (0...20 mA or 4...20 mA). The analog output is galvanically separated from the other meter circuits. Selection of the output type to be used can be done during the output configuration. It is not possible to use the voltage and current output at the same time because it is physically one output with two signals connected to the terminals. It is very important when using an output to choose the type of it that is actually being used. Otherwise, the output value will not match the expected output signal.

The following parameters should be defined during the output configuration:

- **ATYPE** – type of output signal that will be used. Additionally, the manual operation modes are available (separate for the voltage output and for the current output), where AnMAN setting defines the exact expected value on the analog output.
- **InPV** – setting which defines the quantity that will control the analog output signal.
- **AnLo** – lower value of the control signal in accordance with InPV parameter, which the minimum signal value on the analog output corresponds to.
- **AnHi** – upper value of the control signal in accordance with InPV parameter, which the maximum (rated) signal value on the analog output corresponds to.
- **AnMAN** – the parameter has two applications. First, it is the value of the signal (voltage or current) during a manual control of the output. Second, to use a set value when the signal controlling the output has an incorrect value, e.g. exceeded measuring range. In such case the signal on the output will be set according to this setting.

Thus, configuration of the output requires to specify five parameters. An example of an output configuration is shown below.

Let's assume that the input signal is power and the measuring range will be 500 W and for such range the output should change between 4 ... 20 mA. The settings for such case should be as follows:

- AtYPE = 4 20MA.
- InPV = P.
- AnLo = 0.
- AnHi = 500.
- AnMAN = 22. The value on the analog output will be 22 mA in case of a measurement error.

### 5.4.3 Alarm outputs

The N32H meters are equipped with one alarm output as standard. They can have 4 alarm outputs as an option, including three outputs with a switching contact. The alarm output element are electro-magnetic relays. If the meter is physically equipped with one alarm, 4 alarms are still available in the meter menu. In this case, the alarms 2 to 4 can have a indication functions by controlling the alarm indicator on the screen and via the RS-485 interface (alarm states in the meter registers).

Each alarm output is independently configured and can be configured to work in one of six modes. It is possible to select the value controlling the alarm (see Fig. 9), define the alarm state change thresholds and define delays alarm activation and deactivation for each of the alarms. Fig. 11 shows how the alarms work in n-on, n-off, off and on modes. Additional manual working modes H-on and H-oFF enable to permanently activate or deactivate the alarms. An additional REG operation mode has also been added to the alarm type settings. In this mode, the alarm state is controlled via the RS-485 interface by MODBUS protocol registers.



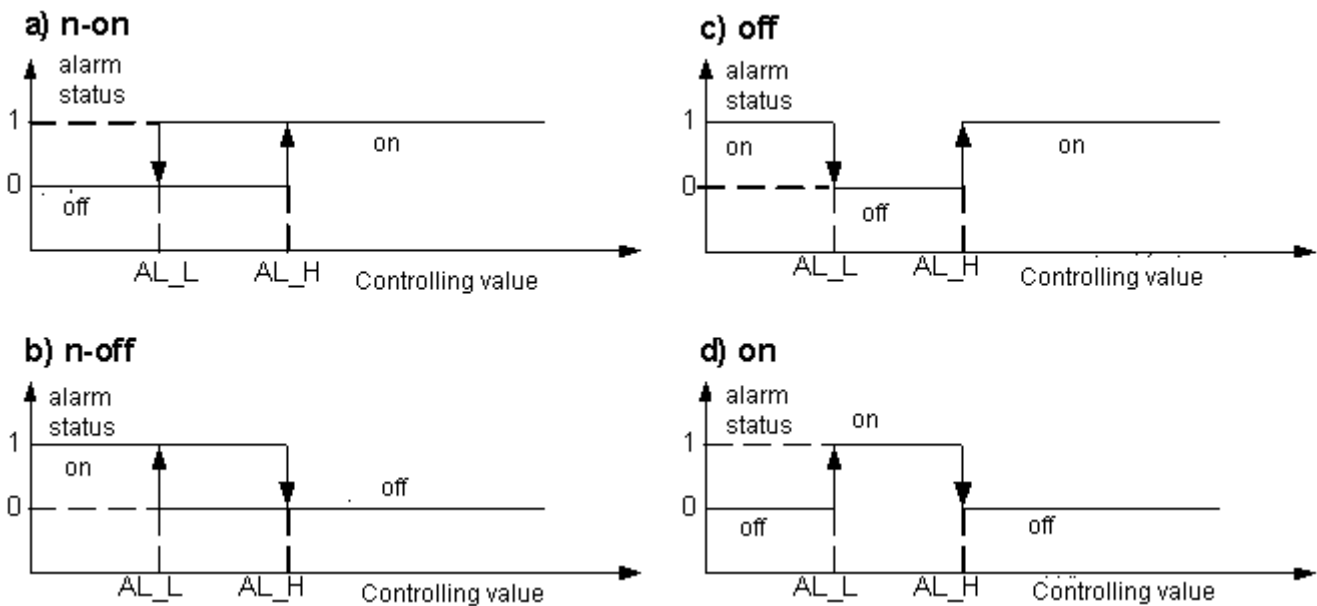

Fig. 11: Alarm types: a) n-on; b) n-off; c) off; f) on.

Designations used in the drawing:

- AL\_L – corresponds to PrL setting and determines the alarm state change lower threshold.
- AL\_H – corresponds to PrH setting and determines the alarm state change upper threshold.

**Note: It is important to keep in mind when configuring the alarms that the entered threshold values should match the dependency  $AL_L < AL_P$ . Otherwise the dependency will disable the alarms.**

Additionally, the alarm functions include the programmable delays of alarm activation and deactivation. The user can define how long the alarm event must last before the alarm relay contacts are switched on and the minimum time of the alarm event end before the relay contacts are switched off. Alarm delays prevent false alarms caused by a short-term change of the measuring value, e.g. during the start-up.

**The alarm event could be registered if the alarm memory is enabled.**

#### 5.4.4 Binary output

The N32H meters can have a galvanically separated optional binary output, which is designed to generate pulses corresponding to the counting of a given portion of energy by the energy counter. Pulse weight (the amount of counted energy per one pulse) is user-defined. This output can be used to transfer information to subsequent counters or PLC controllers, etc.

The binary output has an NPN transistor as the output, its collector and emitter are

connected to the output terminals what enables to work with the inputs of the meters supporting the NPN and PNP sensors.

Duration of each generated pulse is 30 ms followed by a pause of also 30 ms. It is important to pay attention to pulse duration during a configuration of the binary output (pulse weight) because too many generated pulses may overflow the internal pulse counter, and consequently, the number of generated pulses will be lower than expected.

The examples of connecting a binary output to a counter in input configuration for NPN (b) as well as PNP (a) sensors are shown below.

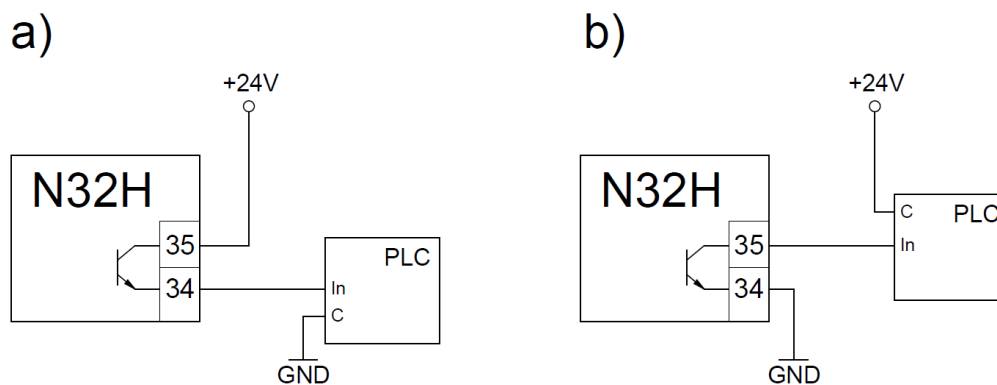

Fig. 12: An example of connecting a binary output to a PLC controller.

The figure above shows the examples of connecting the binary output of the N32H meter to a PLC controller. The diagram in Fig. a shows the controller input to work with PNP sensors, while Fig. b shows a diagram for the controllers to work with NPN sensors.

## 5.5 RS-485 interface

The N32H meters are equipped as a standard with one RS-485 port connected to the terminals of the lower connector. The interface is galvanically separated from the other circuits of the meter.

The implemented data exchange protocol is compatible with MODBUS RTU standard and allows to save and read all configuration parameters as well as read all measurement data with data including alarm status, current time, date or other parameters related to the meter status. The transducer works in the network as a *slave* device.

Standard RS-485 allows a direct connection up to 32 devices on a single serial link. The maximum permissible cable length depends on a baud rate, and it is 1200 m for the baud rate 9600 b/s. It is necessary to use additional intermediate-separation circuits e.g. PD51 by LUMEL S.A. to connect more devices or to use a longer connections.

### 5.5.1 Connection

The terminals A, B and GNDI terminals which location is shown on Fig. 5 allow to connect the RS-485 interface to the N32H meter. It is required to connect the lines A and B in parallel with their equivalents in other devices to obtain the correct transmission.

The connection should be made using twisted pair screened cable in such a way that the A

and B lines should be one pair and are connected with their equivalents of other devices in the network. The cable shield should be connected to the protective terminal in close proximity to the N32H meter. The cable shield of the interface cable should be connected to the protective terminal only in one point.

The GNDI line, which is the reference potential for the RS-485 interface, is used for additional protection of the interface line at long connections. Then all GNDI lines of all devices using the same bus should be connected together.

A star connection should be avoided when connecting the devices. The connection should have a bus layout which ends are connected to the termination resistors.

Method of connecting the devices is shown in Fig. 12.

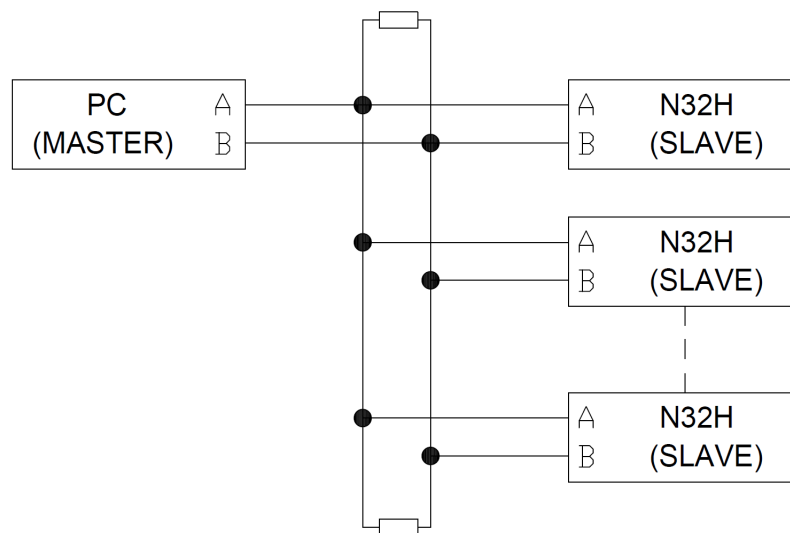

Fig. 13: Connecting the RS-485 interface.

### 5.5.2 Description of the MODBUS protocol implementation.

The implemented protocol is compliant with the PI-MBUS-300 Rev G specification of Modicon.

It is important to keep in mind when configuring the parameters that the devices using the same bus must meet the following requirements:

- Have a unique address, different from the addresses of other devices connected to the network.
- The same baud rate.
- The same type of transmission mode (single data frame format).

The N32H meters enable programming the following parameters of the RS-485 link:

- Meter address: 1...247.
- Baud rate: 2400, 4800, 9600, 14400, 19200, 28800, 38400, 57600, 115200 [b/s].

- Operation mode: RTU frame format 8n1, 8n2, 8o1, 8e1.
- Maximum response time: 50 ms.

### 5.5.3 Implemented functions of MODBUS protocol

The following functions of the MODBUS protocol have been implemented in the N32H meters:

- 03 (03h) – readout of registers group.
- 04 (04h) – readout of input registers group.
- 06 (06h) – single register writing.
- 16 (10h) – registers group writing.
- 17 (11h) – *slave* device identification.

### 5.5.4 Map of the registers

The register map of the N32H meter is divided into separate groups of 16-bit or 32-bit registers. Data stored in 32-bit registers are additionally available in the format of 16-bit registers, with the value of one 32-bit register is stored in two 16-bit registers.

The 32-bit registers store data in the float format compliant with IEEE-754. Bytes sequence: B3 B2 B1 B0 – the oldest byte is transmitted as the first. The 16-bit registers representing 32-bit values in two successive registers have been doubled in another address space with a byte sequence: B1 B0 B3 B2.

The table below shows the register map of the N32H meter. The addresses in the table are the physical addresses. The register number should be increased by 1 when using the programs where the addresses are provided in a logical format.

| Address range | Value type      | Description   |
|---------------|-----------------|---|
| 4000 – 4056   | 16 bits         | Readout and write registers - configuration registers   |
| 4200 – 4267   | 16 bits         | Readout only registers with system parameter values   |
| 7500 – 7528   | 32 bits (float) | Readout only registers with measuring and calculated values.  |
| 7600 – 7614   | 32 bits (float) | Readout and write registers - registers with configuration data.  |
| 7000 – 7057   | 16 bits         | Readout only registers. Registers store the same data as the registers 7500-7528, where one value is stored in two successive registers.      |
| 7200 – 7229   | 16 bits         | Readout and write registers. Registers store the same data as the registers 7600-7614, where one value is stored in two successive registers. |

#### 5.5.4.1 Registers 4000 – 4054

16-bit readout and write configuration registers.

| Address  | Permissible values | Default | Description             |
|--|--------------------|---------|-------------------------|
| Measurement, display and protection of configuration |                    |         |                         |
| 4000   | 0...4              | 0       | Voltage measuring range |

|      |  |     |   |  |
|------|--|-----|---|--|
|      |  |     | Value   | Rated range (measuring range)                |
|      |  |     | 0   | 50 V (-75...75 V)                            |
|      |  |     | 1   | 100 V (-160...160 V)                         |
|      |  |     | 2   | 150 V (-300...300 V)                         |
|      |  |     | 3   | 300 V (-600...600 V)                         |
|      |  |     | 4   | 600 V (-1200...1200 V)                       |
| 4001 | 1...60000                                  | 100 | Rated current of the connected shunt in amperes.  |  |
| 4002 | 30...1500                                  | 60  | Rated voltage of the connected shunt in mV.   |  |
| 4003 | 1...600                                    | 10  | Number of measurements to be averaged. The value specifies a multiple of 100 ms. The measurement after averaging is considered as a single (basic) measurement. |  |
| 4004 | 0, 1                                       | 0   | Method of calculating the measurements average value.   |  |
|      |  |     | Value   | Description                                  |
|      |  |     | 0   | Moving window method.                        |
|      |  |     | 1   | Arithmetic mean - a standard method.         |
| 4005 | 1...60                                     | 15  | Measuring values averaging period in minutes.   |  |
| 4006 | 0, 1                                       | 2   | Averaging period synchronization with the real time clock. The parameter is applicable only if 60 minutes is a multiple of the averaging time.                  |  |
|      |  |     | Value   | Format                                       |
|      |  |     | 0   | Synchronization disabled                     |
|      |  |     | 1   | Synchronization enabled                      |
| 4007 | 0, 1                                       | 0   | Voltage measurement compensation of voltage drop on a shunt   |  |
|      |  |     | Value   | Description                                  |
|      |  |     | 0   | Off  |
|      |  |     | 1   | On   |
| 4008 | 0...13                                     |     | Selection of the main value displayed on the display.   |  |
|      |  |     | Value   | Description                                  |
|      |  |     | 0   | Voltage measuring value                      |
|      |  |     | 1   | Current measuring value                      |
|      |  |     | 2   | Power measuring value                        |
|      |  |     | 3   | Energy counter content                       |
|      |  |     | 4   | Accumulated current counter content          |
|      |  |     | 5   | Voltage mean value                           |
|      |  |     | 6   | Current mean value                           |
|      |  |     | 7   | Power mean value                             |
|      |  |     | 8   | Voltage minimum value in an averaging period |
|      |  |     | 9   | Voltage maximum value in an averaging period |
|      |  |     | 10  | Current minimum value in an averaging period |
|      |  |     | 11  | Current maximum value in an averaging period |
| 12   | Power minimum value in an averaging period |     |   |  |
| 13   | Power maximum value in an averaging period |     |   |  |
| 4009 | 0...6                                      | 6   | Displayed precision - position of the decimal point.  |  |
|      |  |     | 0   | 000000                                       |
|      |  |     | 1   | 00000.0                                      |

|               |  |   |   |  |
|---------------|--|---|---|--|
|               |  |   | 2   | 0000.00  |
|               |  |   | 3   | 000.000  |
|               |  |   | 4   | 00.0000  |
|               |  |   | 5   | 0.00000  |
|               |  |   | 6   | Automatic - the position of the decimal point is set for maximum resolution. |
| 4010          | 0..15                                      | 0 | Contents of the bottom line of the display  |  |
|               |  |   | Value   | Description  |
|               |  |   | 0   | Unit of main displayed value.  |
|               |  |   | 1   | Voltage measuring value  |
|               |  |   | 2   | Current measuring value  |
|               |  |   | 3   | Power measuring value  |
|               |  |   | 4   | Energy counter content   |
|               |  |   | 5   | Accumulated current counter content  |
|               |  |   | 6   | Voltage mean value   |
|               |  |   | 7   | Current mean value   |
|               |  |   | 8   | Power mean value   |
|               |  |   | 9   | Voltage minimum value in an averaging period                                 |
|               |  |   | 10  | Voltage maximum value in an averaging period                                 |
|               |  |   | 11  | Current minimum value in an averaging period                                 |
|               |  |   | 12  | Current maximum value in an averaging period                                 |
|               |  |   | 13  | Power minimum value in an averaging period                                   |
| 14            | Power maximum value in an averaging period |   |   |  |
| 15            | Clock – current time                       |   |   |  |
| 4011          | 0, 1                                       | 0 | Automatic reset of the energy counter and the accumulated current counter   |  |
|               |  |   | Value   | Description  |
|               |  |   | 0   | Function disabled  |
|               |  |   | 1   | Function enabled   |
| 4012          | 0...9999                                   | 0 | Access protection code to make changed in the configuration using the meter menu. It would be required to provide a code each time when entering the meter menu in case of entering a value higher than zero. |  |
| Analog output |  |   |   |  |
| 4013          | 0...5                                      | 0 | Analog output mode.   |  |
|               |  |   | Value   | Description  |
|               |  |   | 0   | Output disabled.   |
|               |  |   | 1   | Output in operating mode 4...20 mA.  |
|               |  |   | 2   | Output in operating mode 0...20 mA.  |
|               |  |   | 3   | Output in operating mode 0...10 V.   |
|               |  |   | 4   | Current output controlled manually.  |
| 5             | Voltage output controlled manually.        |   |   |  |
| 4014          | 0...8                                      | 0 | Quantity controlling the analog output signal   |  |
|               |  |   | Value   | Description  |
|               |  |   | 0   | Voltage measuring value  |
|               |  |   | 1   | Current measuring value  |

|         |  |   |   |                                     |
|---------|--|---|---|-------------------------------------|
|         |  |   | 2   | Power measuring value               |
|         |  |   | 3   | Voltage mean value                  |
|         |  |   | 4   | Current mean value                  |
|         |  |   | 5   | Power mean value                    |
|         |  |   | 6   | Energy counter content              |
|         |  |   | 7   | Accumulated current counter content |
|         |  |   | 8   | Current time                        |
| RS-485  |  |   |   |                                     |
| 4015    | 1...247  | 1 | RS-485 – MODBUS network meter address   |                                     |
| 4016    | 0...3  | 0 | RS-485 – data transmission frame type (format)  |                                     |
|         |  |   | Value   | Frame type                          |
|         |  |   | 0   | 8N1                                 |
|         |  |   | 1   | 8N2                                 |
|         |  |   | 2   | 8O1                                 |
| 4017    | 0...8  | 2 | RS-485 – baud rate.   |                                     |
|         |  |   | Value   | Baud rate [b/s]                     |
|         |  |   | 0   | 2400                                |
|         |  |   | 1   | 4800                                |
|         |  |   | 2   | 9600                                |
|         |  |   | 3   | 14400                               |
|         |  |   | 4   | 19200                               |
|         |  |   | 5   | 28800                               |
|         |  |   | 6   | 38400                               |
|         |  |   | 7   | 57600                               |
| 8       | 115200   |   |   |                                     |
| 4018    | 0, 1   | 0 | RS-485 – Apply entered settings. Entering the value 1 changes immediately the settings and resets the register. If the RS-485 interface parameters have been modified without applying the change, new parameters will be applied after the meter is turned on again. |                                     |
| Alarm 1 |  |   |   |                                     |
| 4019    | 0...8  | 0 | Value controlling the alarm. Significance of the settings as for the register 4014 (quantity controlling the analog output).  |                                     |
| 4020    | 0...6  | 5 | Alarm type (see section 5.4.3)  |                                     |
|         |  |   | Value   | Description                         |
|         |  |   | 0   | n-on                                |
|         |  |   | 1   | n-off                               |
|         |  |   | 2   | on                                  |
|         |  |   | 3   | off                                 |
|         |  |   | 4   | H-on – manually disabled            |
|         |  |   | 5   | H-off – manually enabled            |
| 6       | REG – state controlled by the RS-485 interface |   |   |                                     |
| 4021    | 0...900  | 0 | Alarm activation delay in seconds.  |                                     |
| 4022    | 0...900  | 0 | Alarm deactivation delay in seconds.  |                                     |
| 4023    | 0, 1   | 0 | Alarm activation memory. Entering the value 1 activates the alarm   |                                     |

|  |         |    |   |
|--|---------|----|---|
|  |         |    | event memory function.  |
| <b>Alarm 2</b>   |         |    |   |
| 4024   | 0..3    | 0  | Value controlling the alarm, as for the alarm no. 1.  |
| 4025   | 0...6   | 5  | Alarm type, as for the alarm no. 1.   |
| 4026   | 0...900 | 0  | Alarm activation delay in seconds.  |
| 4027   | 0...900 | 0  | Alarm deactivation delay in seconds.  |
| 4028   | 0, 1    | 0  | Alarm activation memory. Entering the value 1 activates the alarm event memory function.  |
| <b>Alarm 3</b>   |         |    |   |
| 4029   | 0..3    | 0  | Value controlling the alarm, as for the alarm no. 1.  |
| 4030   | 0...6   | 5  | Alarm type, as for the alarm no. 1.   |
| 4031   | 0...900 | 0  | Alarm activation delay in seconds.  |
| 4032   | 0...900 | 0  | Alarm deactivation delay in seconds.  |
| 4033   | 0, 1    | 0  | Alarm activation memory. Entering the value 1 activates the alarm event memory function.  |
| <b>Alarm 4</b>   |         |    |   |
| 4034   | 0..3    | 0  | Value controlling the alarm, as for the alarm no. 1.  |
| 4035   | 0...6   | 5  | Alarm type, as for the alarm no. 1.   |
| 4036   | 0...900 | 0  | Alarm activation delay in seconds.  |
| 4037   | 0...900 | 0  | Alarm deactivation delay in seconds.  |
| 4038   | 0, 1    | 0  | Alarm activation memory. Entering the value 1 activates the alarm event memory function.  |
| <b>Clock – setting only. The registers store data of last entered time and date.</b> |         |    |   |
| 4039   | 0..99   | 19 | Real-time clock – year - value to set the current year.   |
| 4040   | 1...12  | 8  | Real-time clock – month - value to set the current month.   |
| 4041   | 1...31  | 1  | Real-time clock – day - value to set the current day.   |
| 4042   | 0...23  | 12 | Real-time clock – hours - value to set the current hours.   |
| 4043   | 0...59  | 0  | Real-time clock – minutes - value to set the current minutes.   |
| 4044   | 0...59  | 0  | Real-time clock – seconds - value to set the current seconds.   |
| 4045   | 0, 1    | 0  | Automatic change of DST and inversely. Entering the value 1 enables the function of automatic change of DST and inversely.  |
| 4046   | 0, 1    | 0  | Apply entered time. Entering the value 1 sets the clock for the time and date defined in the registers 4037...4042. The register is reset after applying the changes. |
| <b>Alarms - Control</b>  |         |    |   |
| 4047   | 0, 1    | 0  | Alarm 1 - alarm state control for the active alarm in REG mode. Entering the value 1 activates the alarm. Entering the value 0 deactivates the alarm.                 |
| 4048   | 0, 1    | 0  | Alarm 2 - alarm state control for the active alarm in REG mode. Entering the value 1 activates the alarm. Entering the value 0 deactivates the alarm.                 |
| 4049   | 0, 1    | 0  | Alarm 3 - alarm state control for the active alarm in REG mode. Entering the value 1 activates the alarm. Entering the value 0 deactivates the alarm.                 |
| 4050   | 0, 1    | 0  | Alarm 4 - alarm state control for the active alarm in REG mode. Entering the value 1 activates the alarm. Entering the value 0 deactivates the alarm.                 |
| <b>Alarms - Deleting alarm memory</b>  |         |    |   |



|                     |                                   |   |  |  |
|---------------------|-----------------------------------|---|--|--|
| 4051                | 0, 1                              | 0 | Alarm 1 - delete alarm memory. Entering the value 1 deletes the alarm event memory.  |  |
| 4052                | 0, 1                              | 0 | Alarm 2 - delete alarm memory. Entering the value 1 deletes the alarm event memory.  |  |
| 4053                | 0, 1                              | 0 | Alarm 3 - delete alarm memory. Entering the value 1 deletes the alarm event memory.  |  |
| 4054                | 0, 1                              | 0 | Alarm 4 - delete alarm memory. Entering the value 1 deletes the alarm event memory.  |  |
| Additional requests |                                   |   |  |  |
| 4055                | 0, 3                              | 0 | Reset minimum / maximum of measuring value / measuring values. Reset request resets the minimum and maximum values, unless there is no measurement error. Then the reset will be completed after the error is cleared. The value from the register is retrieved and the register is cleared after the request is issued. The register is treated as bits, with each bit corresponding to reset of a different value. |  |
|                     |                                   |   | Bit  | Description                            |
|                     |                                   |   | 0  | Reset voltage minimum measuring value. |
|                     |                                   |   | 1  | Reset voltage maximum measuring value. |
|                     |                                   |   | 2  | Reset current minimum measuring value. |
|                     |                                   |   | 3  | Reset current maximum measuring value. |
|                     |                                   |   | 4  | Reset power minimum measuring value.   |
|                     |                                   |   | 5  | Reset power maximum measuring value.   |
| 6                   | Reset (set) energy counter        |   |  |  |
| 7                   | Reset accumulated current counter |   |  |  |
| 4056                | 0, 1                              | 0 | Restore default settings Entering 1 restores the default settings (default configuration) and resets this register.  |  |

### 5.5.4.2 Registers 4200 – 4233

Readout only 16-bit registers.

| Address           | Description  |
|-------------------|--|
| System parameters |  |
| 4200              | Device ID  |
| 4201              | Software version - version number multiplied by the value 100. |
| 4202              | N32 meter type - code corresponding to the "H" character.      |
| 4203              | Meter serial number - older 16 bits.                           |
| 4204              | Meter serial number - younger 16 bits.                         |
| 4205              | Meter calibration date - older 16 bits.                        |
| 4206              | Meter calibration date - younger 16 bits.                      |
| 4207              | Total meter operation time in seconds - older 16 bits.         |
| 4208              | Total meter operation time in seconds - younger 16 bits.       |
| Real Time Clock   |  |
| 4209              | Current date - year in YY format.                              |
| 4210              | Current date - month.  |
| 4211              | Current date - day.  |
| 4212              | Current time - hour.   |

|  |  |  |
|--|--|--|
| 4213   | Current time - minutes.  |  |
| 4214   | Current time - seconds.  |  |
| 4215   | State of the internal time clock   |  |
|  | Value  | Description                                |
|  | 0  | No clock errors.                           |
|  | 1  | Lost time settings.                        |
|  | 2  | Clock initialization error - faulty clock. |
| 3  | Clock setting error.   |  |
| Alarms - alarm event memory  |  |  |
| 4216   | Alarm 1: Value 1 - active mode to register the alarm event. Value zero - no alarm events registered.   |  |
| 4217   | Alarm 2: Value 1 - active mode to register the alarm event. Value zero - no alarm events registered.   |  |
| 4218   | Alarm 3: Value 1 - active mode to register the alarm event. Value zero - no alarm events registered.   |  |
| 4219   | Alarm 4: Value 1 - active mode to register the alarm event. Value zero - no alarm events registered.   |  |
| Energy counter in Ws - 64-bit  |  |  |
| 4220   | The registers store 64-bit content of energy counter in Ws (Watt seconds), the register 4220 stores the highest 16-bit of the word and the register 4223 stores the lowest 16-bit of the word.   |  |
| 4221   |  |  |
| 4222   |  |  |
| 4223   |  |  |
| Energy counter operation time in the mode with automatic reset (setting) |  |  |
| 4224   | The registers store 32-bit operation time counter of the energy counter in the automatic reset mode. Resolution of the counter is 100 ms. The counter is automatically reset together with the energy counter during an automatic counter reset. The register 4224 stores the older 16 bits. |  |
| 4225   |  |  |
| Reserved   |  |  |
| 4226   | Reserved registers.  |  |
| 4227   |  |  |
| Status bits - value 1 indicates the occurrence of a given event          |  |  |
| 4228   | Communication error with the internal data memory.   |  |
| 4221   | Corrupted configuration registers from register group 4000.  |  |
| 4222   | Corrupted configuration registers from register group 7600.  |  |
| 4223   | Corrupted calibration registers - no calibration.  |  |
| 4224   | The meter is not calibrated.   |  |
| 4225   | Communication error with the analog output module.   |  |
| 4226   | Measurement module error.  |  |
| 4227   | Communication error with A/D converter.  |  |
| 4228   | Voltage range exceeded.  |  |
| 4229   | Current range exceeded.  |  |
| 4230   | Power range (voltage or current) exceeded.   |  |
| 4231   | Loss time - not set RTC clock.   |  |
| 4232   | Alarm 1 active.  |  |
| 4233   | Alarm 2 active.  |  |
| 4234   | Alarm 3 active.  |  |
| 4235   | Alarm 4 active.  |  |

### 5.5.4.3 Registers 7500 – 7515 and 7000 – 7031

The 32-bit and the corresponding 16-bit registers with measuring and calculated data. The address entered in the address field is for 32-bit float variables or in the second column for the values stored in two 16-bit registers, where the value stored in two registers is of float type.

| Address<br>(32-bit float<br>registers) | Address<br>(value in<br>2 16-bit<br>register<br>s) | Description  |
|--|--|--|
| 7500                                   | 7000   | Device ID  |
| 7501                                   | 7002   | Voltage measuring value in [V]                                 |
| 7502                                   | 7004   | Current measuring value in [A]                                 |
| 7503                                   | 7006   | Power measuring value in [W]                                   |
| 7504                                   | 7008   | Value of counted energy [kWh]                                  |
| 7505                                   | 7010   | Value of accumulated current counter [Ah]                      |
| 7506                                   | 7012   | Voltage mean value [V]   |
| 7507                                   | 7014   | Current mean value [A]   |
| 7508                                   | 7016   | Power mean value [W]   |
| 7509                                   | 7018   | Registered voltage minimum value [V]                           |
| 7510                                   | 7020   | Registered voltage maximum value [V]                           |
| 7511                                   | 7022   | Registered current minimum value [A]                           |
| 7512                                   | 7024   | Registered current maximum value [A]                           |
| 7513                                   | 7026   | Registered power minimum value [W]                             |
| 7514                                   | 7028   | Registered power maximum value [W]                             |
| 7515                                   | 7030   | Voltage minimum value in current averaging period [V]          |
| 7516                                   | 7032   | Voltage maximum value in current averaging period [V]          |
| 7517                                   | 7034   | Current minimum value in current averaging period [A]          |
| 7518                                   | 7036   | Current maximum value in current averaging period [A]          |
| 7519                                   | 7038   | Power minimum value in current averaging period [W]            |
| 7520                                   | 7040   | Power maximum value in current averaging period [W]            |
| 7521                                   | 7042   | Reserved   |
| 7522                                   | 7044   | Reserved   |
| 7523                                   | 7046   | Instantaneous voltage value at the voltage input [V]           |
| 7524                                   | 7048   | Instantaneous voltage value at the current measuring input [V] |
| 7525                                   | 7050   | Instantaneous power value                                      |
| 7526                                   | 7052   | Voltage of the backup battery.                                 |
| 7527                                   | 7054   | CPU temperature.   |
| 7528                                   | 7056   | Current time in the form of hh.mmss.                           |









#### 5.5.4.4 Registers 7600 – 7677 and 7200 – 7355

The 32-bit and the corresponding 16-bit registers with the configuration parameters.

| Address (32-bit float registers)              | Address (value in 2 16-bit registers) | Permissible values | Default | Description   |
|---|---------------------------------------|--------------------|---------|---|
| <b>Minimum and maximum displayed value</b>    |                                       |                    |         |   |
| 7600  | 7200                                  | -99999M...999999M  | -99999  | Display narrowing lower threshold. If the value to be displayed is below the threshold, the lower limit symbol is displayed.              |
| 7601  | 7202                                  | -99999M...999999M  | 999999  | Display narrowing upper threshold. If the value to be displayed is above the threshold, the upper limit symbol is displayed.              |
| <b>Reactive energy</b>                        |                                       |                    |         |   |
| 7602  | 7204                                  | -99999M...999999M  | 0       | Energy value to be written to the energy counter when resetting the energy counter.   |
| 7603  | 7206                                  | 0.001...999999     | 1       | Pulse weight at the energy output (energy equivalent)   |
| <b>Analog output</b>                          |                                       |                    |         |   |
| 7604  | 7208                                  | -99999M...999999M  | 0       | The quantity of the value controlling the analog output for which the output will have the minimum value (according to the output range). |
| 7605  | 7210                                  | -99999M...999999M  | 100     | The quantity of the value controlling the analog output for which the output will have the maximum value (according to the output range). |
| 7606  | 7212                                  | 0...22             | 0       | The value of the analog output signal for manual operation or during a measurement error at the input.                                    |
| <b>Alarms – alarm state change thresholds</b> |                                       |                    |         |   |
| 7607  | 7214                                  | -99999M...999999M  | 10      | Alarm 1 – alarm state change lower threshold.   |
| 7608  | 7216                                  | -99999M...999999M  | 20      | Alarm 1 – alarm state change upper threshold.   |
| 7609  | 7218                                  | -99999M...999999M  | 10      | Alarm 2 – alarm state change lower threshold.   |
| 7610  | 7220                                  | -99999M...999999M  | 20      | Alarm 2 – alarm state change upper threshold.   |
| 7611  | 7222                                  | -99999M...999999M  | 10      | Alarm 3 – alarm state change lower threshold.   |
| 7612  | 7224                                  | -99999M...999999M  | 20      | Alarm 3 – alarm state change upper threshold.   |
| 7613  | 7226                                  | -99999M...999999M  | 10      | Alarm 4 – alarm state change lower threshold.   |
| 7614  | 7228                                  | -99999M...999999M  | 20      | Alarm 4 – alarm state change upper threshold.   |

## 6 Error codes

The N32H meters have several diagnostic functions and settings built-in that allow to limit the displaying. So the display may show and the status registers may store information about the diagnosed error, event or fault. Possible messages and their potential causes are listed below.

| Message   | Description   |
|---|---|
|    | Measuring range lower value or the programmed indication range exceeded. The message may also suggest a short circuit in the sensor circuit.  |
|    | Measuring range upper value or the programmed indication range exceeded.  |
|    | It is not possible to display the measuring value in the selected resolution - the measurement result does not fit on the display. Lower the display resolution or select the mode of automatic position of the decimal point.  |
|    | Lost calibration. Please contact the technical support.   |
|   | Lost real time clock settings. The message is displayed only when turning the meter on. Time and date must be set. If the message still appears when turning the meter on after setting the time and date, please contact the Service Department because a backup battery may require to be replaced. This message can be ignored if the clock settings are not significant in a given application. |
|  | Measurement module error. It is not possible to make a measurement, please contact the technical support.   |
|  | Configuration data memory and calibration memory error. It is not possible to use a meter, please contact the technical support.  |
|  | No communication with the analog output module. Please contact the Service Department.  |

## 7 Technical data

### Measuring ranges

| Input type<br>(rated range)                               | Indication range<br>(rated range) | Class   |
|---|-----------------------------------|---------|
| Voltage measuring loop                                    |                                   |         |
| Voltage 50 V  | -75...75 V (50 V)                 | 0.1     |
| Voltage 100 V   | -160...160 V (100 V)              |         |
| Voltage 150 V   | -300...300 V (150 V)              |         |
| Voltage 300 V   | -600...600 V (300 V)              |         |
| Voltage 600 V   | -1200...1200 V (600 V)            |         |
| Current measuring loop (voltage measurement of the shunt) |                                   |         |
| Shunt to 77 mV  | -150...150 mV (75 mV)             |         |
| Shunt to 153 mV   | -300...300 mV (150 mV)            |         |
| Shunt to 305 mV   | -600...600 mV (300 mV)            |         |
| Shunt to 610 mV   | -1200...1200 mV (600 mV)          |         |
| Shunt above 610 mV  | -2400...2400 mV (1500 mV)         |         |
| Power measurement   | All ranges                        | 0.2     |
| Current time  | 00.00...23.59                     | ±20 ppm |

### Measuring loops parameters

|   |                |
|---|----------------|
| Input resistance for voltage measurements   | > 3.5 MΩ       |
| Input resistance for low voltage shunt input  | 100 kΩ         |
| Short-term overload (5s)<br>- voltage input (voltage measurement)<br>- voltage input (voltage measurement on the shunt) | 2.5 Un<br>2 Un |

### Additional measurement errors

|                                   |                     |
|-----------------------------------|---------------------|
| Due to ambient temperature change | 50% of class / 10 K |
|-----------------------------------|---------------------|

### RS485 interface

|                              |  |
|------------------------------|--|
| Galvanic separation          | From all other signal connections      |
| Protocol                     | MODBUS RTU                             |
| Supported protocol functions | 3, 4, 6, 16, 17                        |
| Data frame type              | 8N1, 8N2, 8O1, 8E1                     |
| Baud rate [b/s]              | 2400, 4800, 9600, 14400, 19200, 28800, |

|  |                      |
|--|----------------------|
|  | 38400, 57600, 115200 |
|--|----------------------|

### Alarm outputs:

- NO relay: 5 A / 250 V AC; 5 A / 30 V DC (listed current values are the maximum permissible values. Operation at maximum load significantly shortens lifespan of the relay).
- Three relays with a switching contact (option): 6 A / 250 V AC; 6 A / 30 V DC; 0.15 A / 250 V DC. Maximum switching current 10 A / 20 ms.

### Analog output

| Voltage output                  |                                     |
|---------------------------------|-------------------------------------|
| Rated range                     | 0...10 V                            |
| Maximum output voltage          | < 15 V                              |
| Minimum load resistance         | 500 Ω                               |
| Intrinsic error                 | 0.1 % of range                      |
| Error due to temperature change | 50% of intrinsic error value / 10 K |
| Current output                  |                                     |
| Rated range                     | 0...20 mA; 4...20 mA                |
| Maximum output voltage          | < 15 V                              |
| Maximum load resistance         | 500 Ω                               |
| Maximum current value           | 24 mA                               |
| Intrinsic error                 | 0.1% of range                       |
| Error due to temperature change | 50% of intrinsic error value / 10 K |

### Rated operating conditions

|   |  |
|---|--|
| Supply voltage (depends on the version) | 85...253 V AC (40...400 Hz), 90...300 V DC<br>or<br>20...40 V AC (40...400 Hz), 20...60 V DC |
| Power consumption                       | < 6 VA   |
| Working temperature                     | -20... <u>23</u> ...+55 °C   |
| Storage temperature                     | -30...70 °C  |
| Humidity                                | <95 % (no condensation)  |
| Working position                        | any  |
| Pre-heating time                        | 15 minutes   |

**Protection grade ensured**

|                         |      |
|-------------------------|------|
| From the front          | IP65 |
| From the terminals side | IP10 |

**Weight and dimensions**

|                         |                 |
|-------------------------|-----------------|
| Meter weight            | < 0.2 kg        |
| Dimensions (see Fig. 3) | 96 x 48 x 93 mm |

**Electromagnetic compatibility**

|                 |                      |
|-----------------|----------------------|
| Noise immunity: | acc. to EN 61000-6-2 |
| Noise emission: | acc. to EN 61000-6-4 |

**Safety requirements acc. to EN 61010-1**

|   |  |
|---|--|
| Circuit-to-circuit insulation:            | basic  |
| Installation category:                    | III  |
| Pollution grade                           | 2  |
| Maximum phase-to-earth operating voltage: | *600 V for the measurement circuits.<br>300 V for the circuits: supply, alarm.<br>50 V for the circuits: auxiliary supply, RS-485 interface, analog output |
| Altitude a.s.l.                           | < 2000 m   |

\* 1000 V for the measurement circuits of installation category II.



## 8 Ordering code

|   |        |             |                     |   |                  |
|---|--------|-------------|---------------------|---|------------------|
| <b>Panel meter N32H type:</b>   | X      | X           | XXXXXXXX            | X | X                |
| <b>Supply voltage</b><br>85..253 V AC, 90...300 V DC<br>20...40 V AC, 20...60 V DC  | 1<br>2 |             |                     |   |                  |
| <b>Outputs / Interface</b><br>1 relay output, RS-485<br>4 relay outputs, RS-485<br>4 relay outputs, RS-485, 1 analog output                                 |        | 1<br>2<br>3 |                     |   |                  |
| <b>Version</b><br>standard<br>custom-made*  |        |             | 0000000<br>XXXXXXXX |   |                  |
| <b>Language version</b><br>Polish - English*  |        |             |                     | M |                  |
| <b>Acceptance tests</b><br>without extra requirements<br>with quality inspection certificate<br>with calibration certificate<br>acc. to customer's request* |        |             |                     |   | 0<br>1<br>2<br>X |

- only after agreeing with a manufacturer.