

User Manual

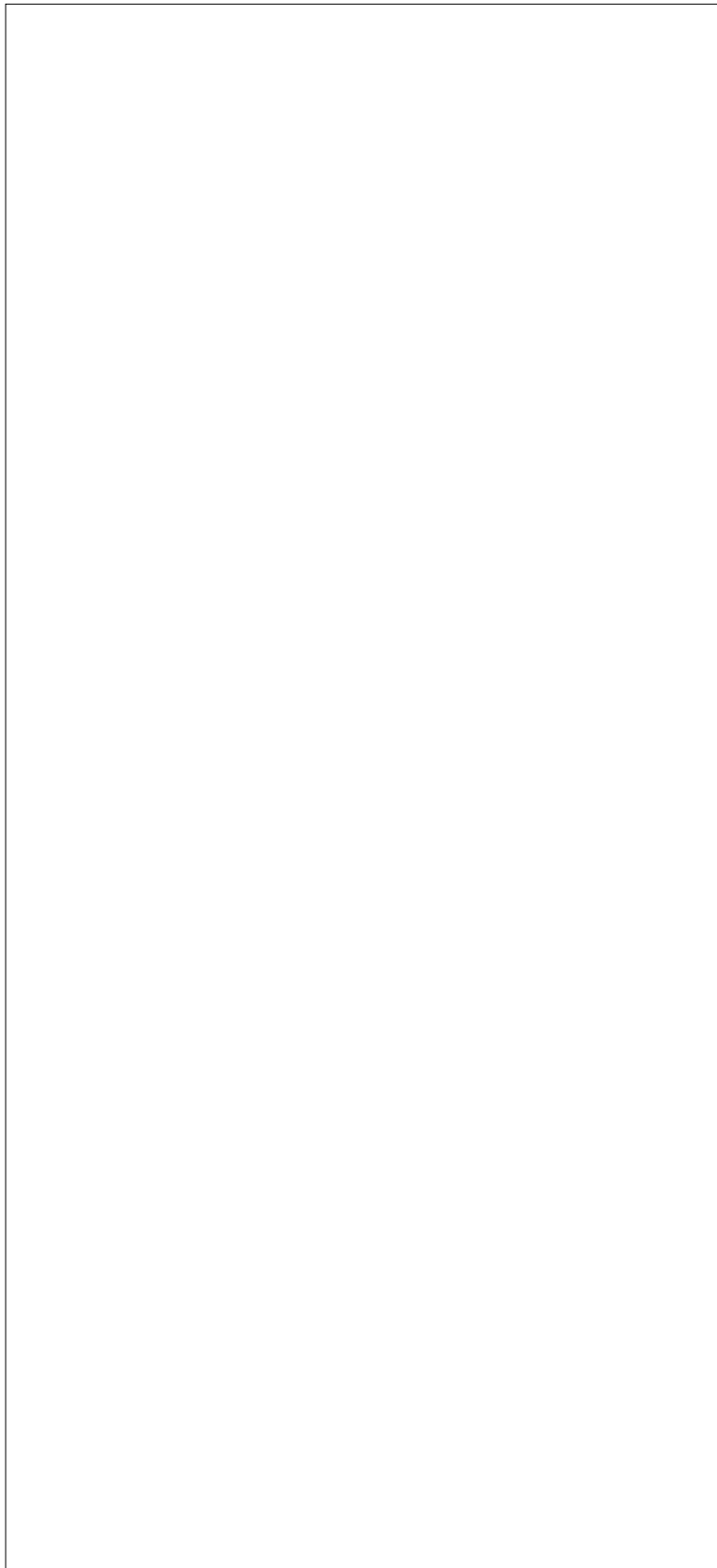

Delta Power BT 1000A/400A AC-DC





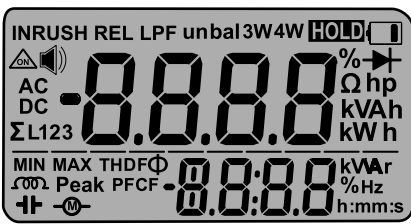
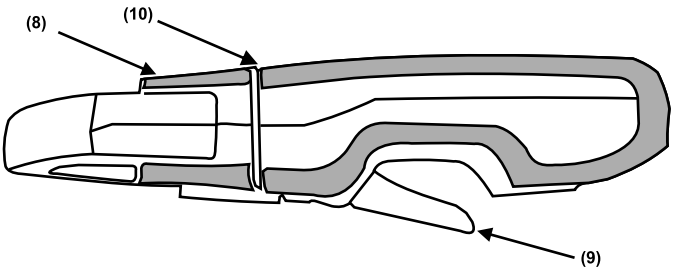
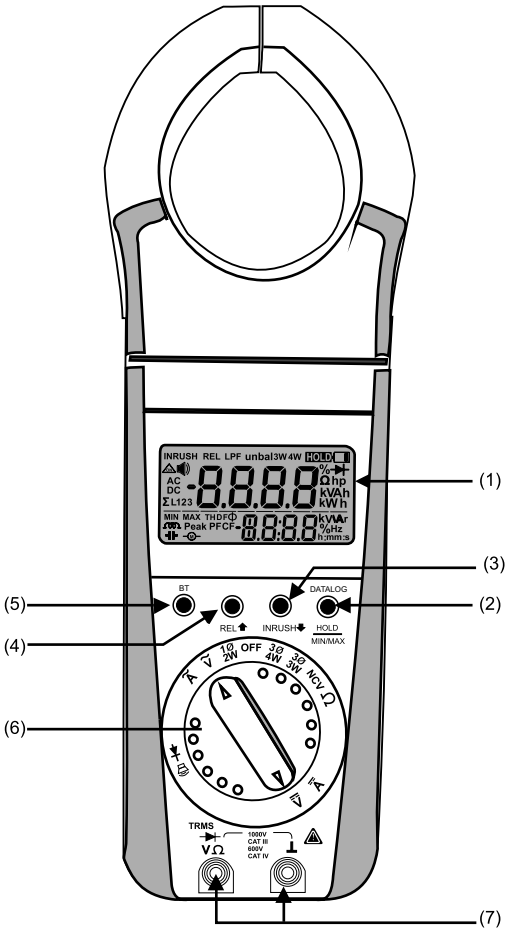

- | | |
|---|--|
| (1) Liquid crystal display | (5) Push button to change Function and to turn ON Bluetooth. |
| (2) Push button for data hold, MIN/MAX and Datalogging storage functions. | (6) Function selector switch. |
| (3) Push button for Down and Inrush | (7) Terminal sockets |
| (4) Push button for Up and Relative Function. | (8) Rotary mechanism for clamp jaws. |
| | (9) Safe trigger mechanism. |
| | (10) Limit of safe access for hand held. |

Contents	Page
1. Introduction , Application and Features	3
2. Safety features and safety precautions.....	3
3. Switching the Power Clamp meter "ON".....	5
4. Liquid crystal display and backlight.....	6
5. Advanced Data "HOLD"	7
6. Minimum value and maximum value"MIN/MAX storage facility	8
7. Relative Function	9
8. Voltage measurement	10
8.1 THD	10
8.2 DF	10
8.3 CF	11
8.4 Peak Min/ Peak Max.....	11
8.5 Frequency.....	11
8.6 Individual Harmonic measurement	11
8.7 LPF.....	11
9. Current measurement.....	13
9.1 THD	14
9.2 DF	15
9.3 CF	15
9.4 Peak Min/ Peak Max.....	15
9.5 Frequency.....	15
9.6 Individual Harmonic measurement	15
9.7 LPF.....	15
9.8 Inrush Current measurement	17
9.9 Ampere hour measurement.....	18
10. 1Ph Power measurement	19
10.1 kVA,kW ,kVAr	19
10.2 PF & Φ	19
10.3 HP	19
10.4 DC Power	19
10.5 kWh measurement	22
11. 3-Phase 4 wire Power measurement	23
11.1 3 Ph 4W unbalance Load Power	23
11.2 3 Ph 4W balance Load Power.....	25
12. 3 Phase 3 Wire Power measurement	27
12.1 3 Ph 3W unbalance Load Power	27
12.2 3 Ph 3W balance Load Power.....	29
13. NCV Detection.....	31
14. Resistance, continuity & Diode measurement.....	31
15. Empty Positions.....	32
16. Data logging mode.....	32
17. Bluetooth Connection.....	33
18. Specifications.....	36
19. Maintenance	40
19.1 Battery	40
19.2 Periodic Check-up.....	40
20. Servicing	40

1. Introduction , Application and Features:

Delta Power BT meter is a Portable Digital multi functional measuring instruments designed for Measuring selected power network parameters, AC/DC voltage, AC/DC current, Resistance, Continuity, Diode and Frequency. Apart From basic quantities meter enables the measurement of additional quantities calculated from values of voltage and current.

Delta Power BT meter is innovatively designed for increasing safety and comfort of user. Rotating clamp jaws facilitate the measurement at physically awkward position, vertical bus bars , conductors placed at position difficult to access. Clamp jaws can be opened or closed with the triggered placed at bottom side placed away from the jaws . This allows the user to place his/her hand at safer distance from live conductor.

Location and design of trigger eliminates fatigues caused by single finger operation. It allows spreading the force required to open the jaws over more than one finger to ensure comfortable operation.

Bluetooth facility gives additional features to meter. A meter can be used for automation as it can communicate with PC and phone. Increases documentation speed as a software generate report for a parameter. android application provides a virtual display, trend plot of parameters and data logging.

Delta Power BT meter have following features

- Bluetooth connectivity with PC Software and Mobile Application
- Data logging in meter (2000 to 40000 reading depends on function)
- AC & DC Voltage up to 1000V (True RMS)
- AC & DC Current up to 1000A/400A (True RMS)
- Inrush Current Measurement
- Single Phase kW, kVA and kVA measurement
- Unique Three Phase kW, kVA, kVA measurement using single meter
- Horse Power Measurement
- kWh, Ahr Measurement
- Measure up to 49th Harmonics
- Phase Angle
- Power Factor
- Total Harmonics Distortion Measurement (THD)
- Distortion Factor (DF)
- Crest Factor (CF)
- Peak Value Measurement LPF mode for VFD measurement
- Advanced Hold Function to hold multiple parameters
- NCV (Non-Contact Voltage) Detection

2. Safety features and safety precautions

Delta Power BT meter provides a very high degree of safety.

The digital Delta power BT meter 400A/1000A manufactured and tested in compliance with the safety standard IEC 61010-1:2010.

In case of incorrect use or careless handling, the safety of both user and power clamp meter is not assured.

For proper use and safe handling, it is absolutely necessary to read and understand the operating instructions before using the clamp meter.

Please note the following safety precautions:

- Operators must use individual protective equipment if hazardous live parts of installation could be accessible.
- Keep hands/fingers behind the edge that separates rotating jaws with hand held part(10). This is the limits of the hand held part during measurement.
- The clamp meter must be operated only by persons who understand the danger of shock hazards and are aware of the necessary safety precautions. Shock hazards exist wherever voltages of more than 30V(TRMS) are present.

- Do not work alone in shock hazardous environment while carrying out measurement.
- The maximum permissible voltage between any of the terminal sockets (7) and ground is 1000V.
- Take into account that unexpected voltages can occur on device under test (e.g.defective instrument). For example, capacitors may be charged to a dangerously high voltage.
- Verify that the test leads are in good condition, e.g.no cracked insulation, no open circuits in the leads or connectors.
- This clamp meter must not be used for measurements on circuits with corona discharge (high voltage).
- Be particularly careful when measuring on HF circuits. Dangerous composite voltages may exist there.
- Measurements under moist environmental conditions are not permitted.
- Do not overload the measuring ranges beyond their allowable capacities. Limit values are given in specifications. Ref. Chapter 16.
- Please verify the performance of clamp meter after repairing of the meter, before using it for actual measurement.
- Do not use the clamp meter if obvious wear in jaw opening is visible.
- Protection provided by the digital clamp meter may be impaired if the clamp meter is not used in a manner specified in this user manual.

Meaning of categories and their significance as per IEC61010-1

CAT I: Measurements in electrical circuits which are not directly connected to the mains: for example electrical systems in motor vehicles and aircraft, batteries etc.

CAT II: Measurements in electrical circuits which are electrically connected to the low-voltage mains: with plugs, e.g. at home, in the office or laboratory etc.

CAT III: Measurements in building installations, stationary power consumers, distributor terminals, devices connected permanently to the distributor.

CAT IV: Measurements at power sources for low-voltage installations, meters, mains terminals, primary over voltage protection devices.

Meaning of the symbols on the device



Warning of a danger point
(Attention, refer to the user manual)



Earth (ground) terminal.



Double or reinforced insulation

CAT III/IV

Instrument for over voltage
category III OR IV

Repair, replacement of parts:

When opening the meter, live parts may be exposed. Therefore, the meter must be disconnected from the measuring circuit prior to opening its case for repair or replacement of parts. If repair cannot be avoided unless the meter is opened and live, this work must only be performed by a qualified person who understands the danger involved.

Faults and abnormal stress:

When it is realized that the safe operation is no longer possible, take the meter out of service and secure it against accidental use.

Safe operation may not be possible,

- when the meter shows obvious signs of damage,
- when the meter no longer functions correctly,
- after prolonged storage under adverse conditions,
- due to severe stress during transportation.

3. Switching the Power Clamp meter "ON"

Battery

We have already fitted your meter with a 9V flat cell battery according to IEC 6F22 or IEC 6R61. It is ready for operation. Before you use the meter for the first time or after storage, refer to section " 17.1 Maintenance battery"

Switching the meter "ON"

- Rotate the function selector switch or knob from "OFF" position to another. Switch-"ON" is acknowledged by a sound signal.

Note:

Electric discharges and high-frequency influence may cause incorrect information to be displayed and block the measuring process. Reset the meter by switching it OFF and ON again otherwise, check the battery connections.

Disconnect the clamp meter from the measuring circuit before you open it, and see section "17. Maintenance".

Automatic TURN-OFF

The meter turns off automatically, when neither a push button nor the function selector switch is operated for about 10 minutes.

How to prevent automatic TURN-OFF

In order to prevent automatic "TURN OFF" select "CONTINUOUSLY ON" mode. For this, press "Down and Inrush" push button and the "Min/Max and Hold" pushbutton together. The function "CONTINUOUSLY ON" is shown on the LCD by the symbol. 



Turning the clamp meter OFF



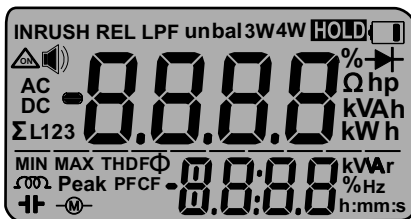

Rotate the function selector switch to "OFF" position.

4. LCD & Backlight



LCD of Clamp meter is as shown above. The digital display shows measured value with sign. Description of remaining symbol is as follow.

V	Volts
A	Amperes
W	Active Power
VA	Apparent Power
VAr	Reactive Power
Ah	Ampere Hour
Wh	Watt Hour
INRUSH	AC Inrush Current Measurement
REL	Relative Measurement
LPF	Low Pass Filter
unbal	Un Balance
bal	Balance
HOLD	Hold function
3W	Three Wire
4W	Four Wire
	Continuous ON or Bluetooth enable or Data logging enable
	Continuity Mode
AC	Alternating current
DC	Direct current
Ω	Resistance Measurement
hp	Horse Power

L1	Phase 1 Readings
L2	Phase 2 Readings
L3	Phase 3 Readings
ΣL123	Three phases system parameters
MIN	Minimum Value
MAX	Maximum Value
	Low Battery
	Diode Measurement
	Inductive
	Capacitive
THD	Total Harmonic Distortion
DF	Distortion Factor
PF	Power Factor
CF	Crest Factor
Φ	Phase Angle
Peak	Peak Value of Current or voltage
Hz	Hertz
k	Multiplied by 1000(Kilo)
h:mm:s	Hours:Minutes:Seconds
	Motor application

Backlight

The instrument is provided with Backlight for taking measurements in poor lighting conditions/dark areas.

Switching the Backlight ON

by pressing "MULTIFUNCTION (YELLOW)" and "UP / REL" keys simultaneously the Backlight can be switched ON.

Switching the Backlight OFF

by pressing "MULTIFUNCTION (YELLOW)" and "UP / REL" keys simultaneously the Backlit can be switched OFF.

5. Advanced Data "HOLD"

The HOLD function allows to automatically hold the measured values. The meter holds the measured value on the digital display with a sound signal and displays "HOLD" on LCD display. The probes or clamp can now be removed from the measuring point and the measured value on the digital display can be read.

Why We Call this as ADVANCED HOLD Function ?

Because, in this hold function we can hold all the parameters at a time which are measured in that mode.

For e.g. 1) we are measuring single phase AC power. In AC power function we can measure Voltage, Current, Active Power, Reactive Power, Apparent Power, Phase Angle, Power Factor and Horse Power. Now if we press hold key on any one of the parameter screen then not only that parameter but all other measured parameter gets hold. It benefits to see all other parameter on single hold. e.g. 2) Suppose we are measuring AC Current. In AC Current function we can Current, THD, DF, CF, Peak, Frequency, Harmonics Up to 49.

Now if we press hold key on any one of the parameter screen then not only that parameter but all other measured parameter gets hold. including all 49 harmonics.

So Advanced Hold feature benefits user to make data analysis of different parameters even after removal of input .

To activate "HOLD " function, momentarily press (short press) the "HOLD / MIN MAX" key.

The data HOLD function is switched OFF, when

- ☛ The "**HOLD**" pushbutton is pressed for approx. 2sec (long press). This is acknowledged by sound signals.
- ☛ The function selector switch is operated.
- ☛ The Clamp meter is turned OFF and ON again.

The "HOLD / MIN MAX" key will not be enabled in 3 phase power measurement unless and until measurement of power is done.

The "HOLD / MIN MAX" key will be disabled in NCV, kWh, Ahr functions.

HOLD function not applicable for 3P4W, 3P3W unbalanced system Diode and Continuity .

6. Minimum value and Maximum value "MIN / MAX" storage facility.

With the MIN/MAX function, we can hold the minimum and the maximum measured value which was applied to the input of the clamp meter after activating MIN/MAX function. The most important application is the determination of the minimum and the maximum value for long-term monitoring of measured quantities.

To activate "MIN MAX " function, press the "HOLD / MIN MAX" key twice. The data "MIN MAX " function is switched OFF, when

- ☛ The "**HOLD / MIN MAX**" pushbutton is pressed for approx. 2s. (long press) This is acknowledged by sound signals.
- ☛ The function selector switch is operated
- ☛ The Clamp meter is turned OFF and ON again.
- ☛ "MIN MAX" is not applicable for Harmonics and the parameters on sub display "MIN MAX" is also not applicable for 3P3W and 3P4W unbalanced load. Figure 6.1 will show procedure for entering in hold and min max functions

Fig 6.1: Screens for HOLD/MIN/MAX

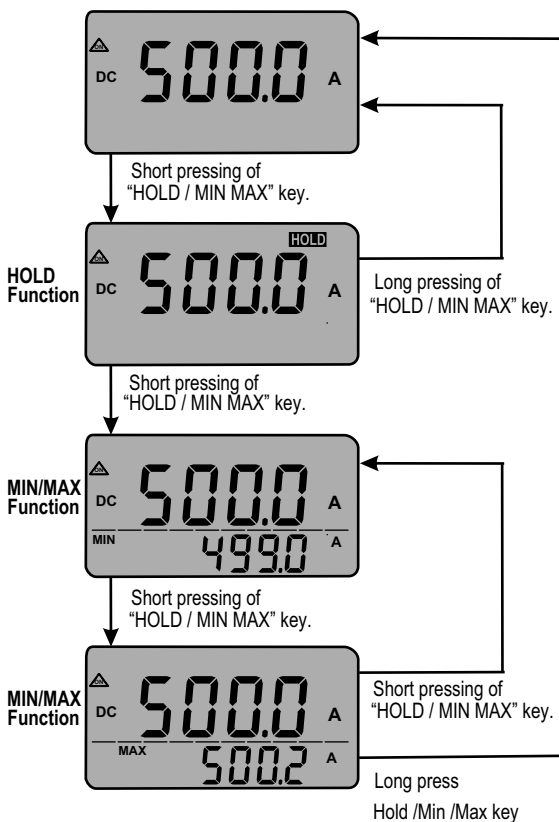

7. Relative Function(REL)

With the REL function, we can see the measured value with respect to some value.

REL function is applicable for Voltage, Current and Resistance functions only.

To activate "Relative" function, press the "UP/REL" key.

The "REL" function is switched OFF, when

- ☛ The "UP / REL" pushbutton is pressed (short press)
This is acknowledged by sound signals.
- ☛ The function selector switch is operated
- ☛ The Clamp meter is turned OFF and ON again.

8. Voltage measurement

- ☛ According to the voltage to be measured, set the function selector switch to \tilde{V}
- ☛ Connect the test leads as shown in fig 8.1. The “⊥” socket should be connected to the lowest potential ground available.
- ☛ Select the appropriate working mode i.e. AC or DC or ACDC by long pressing Yellow key (Function key).

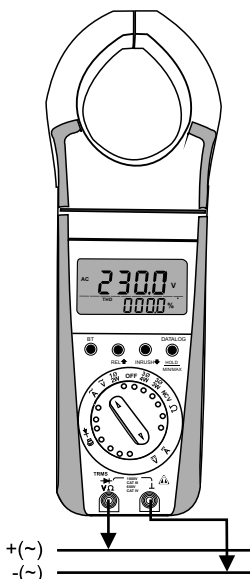

Fig 8.1 Voltage measurement on electrical systems up to 1000V

For AC voltage mode following parameters measured.

8.1 THD (Total Harmonic Distortion)

Power Clamp meter can measure THD up to 49th Harmonic.
By default meter is present on THD measurement screen.

$$THD = \sqrt{\frac{\sum_{n=2}^{49} (\text{n}^{\text{th}} \text{ order harmonic voltage RMS value})^2}{(\text{Fundamental wave voltage RMS value})^2}} \times 100 \%$$

8.2 DF (Distortion Factor)

Power Clamp Power can measure DF up to 49th Harmonic.

$$DF = \sqrt{\frac{\sum_{n=2}^{49} (\text{n}^{\text{th}} \text{ order harmonic voltage RMS value})^2}{(\text{Voltage RMS value})^2}} \times 100 \%$$

8.3 CF (Crest Factor)

Delta Power BT meter can measure CF. CF is the ratio between the value the peak voltage and corresponding RMS voltage.

$$CF = \frac{V_m \text{ (Peak Voltage Value)}}{V_{RMS} \text{ (RMS Voltage Value)}}$$

8.4 Peak Max / Peak Min

Peak Max /Min is the Positive / Negative peak value of measuring waveform. It updates continuously as per measuring waveforms peak.

8.5 Frequency

Delta Power BT meter measures frequency from 45 to 65 Hz.

8.6 Individual Harmonic measurement

Delta Power BT meter can measure individual harmonic voltage up to 49th Harmonic. Measured harmonic can also be seen in percent (%) w.r.t. fundamental voltage.

8.7 LPF measurement mode

Delta Power BT meter have LPF mode for voltage measurement. In LPF mode meter measures voltage below cut off frequency. The cutoff frequency of clamp meter for LPF mode is 400 Hz. This means that meter will measure voltage having frequency below 400 Hz.

- ☛ Note : 1) If display shows OL then it indicates Voltage Overload i.e > 1020 V .
- ☛ To enter in LPF mode Simultaneously press “yellow function key” and “Hold/Min/Max” keys.



Fig 8.2 Low Pass Filter mode

- Note :**
- 1) “----” is displayed for THD, DF, CF, Freq and Harmonics if voltage level is below measurement band or applied voltage is OL value i.e. 1020 V
 - 2) “----” is displayed for THD, DF and Harmonics if signal frequency is out of measuring band i.e. Freq Except 45Hz...65Hz
 - 3) Meter will display 0 V if V <0.5V and in LPF mode meter will display 0 V if V < 1V

Voltage measurement

Knob Position

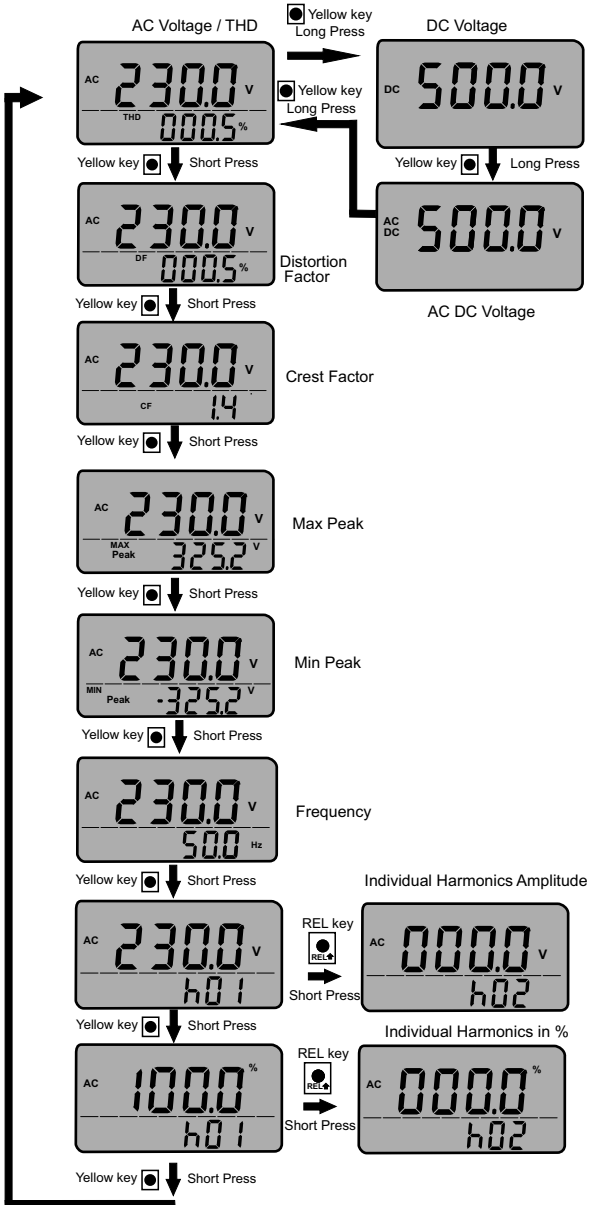

Fig 8.3 Voltage measurement screens

9. Current measurement

- Set the function selector switch to A~.
- Connect the Clamp as shown in figure 9.1 for current measurement. To measure current through cable push the trigger (present at back) to open the jaws and clamp the jaws around the cable as shown in fig 9.1

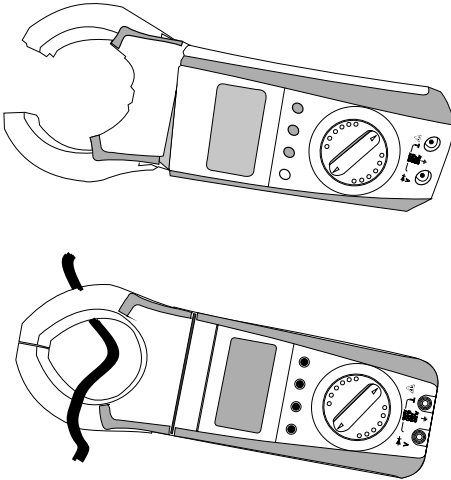

Figure 9.1

- Select the appropriate working mode i.e. AC or DC or ACDC by long pressing yellow key (Function key).

Unique design for safety and comfort

Rotary mechanism for clamp jaws:

In conventional clamp meters display, keys and clamp jaws are in the same plane. When current measurement is to be done on vertical bus bars, overhead cables, cables in congested places user connect the clamp meter but the keys and display may not be visible, hence not able to take the readings or operate the keys.

To overcome the above mentioned problem Delta Power BT meter 400A/1000A has a unique feature called "Rotary mechanism for clamp jaws". In this, the clamp jaws are rotating. Hence it is possible to align the clamp jaws as the orientation of bus bar/conductor while keeping Display and keys facing the user, so that user can take the readings and operate the keys.

Rotary clamp jaws can be rotated at different angles with the step of 30° , maximum up to 90° in both clock-wise as well as anti-clock wise direction as shown in figure 9.2

Note :- For better accuracy of current, position conductor at the marking on the jaw (center of the jaw)

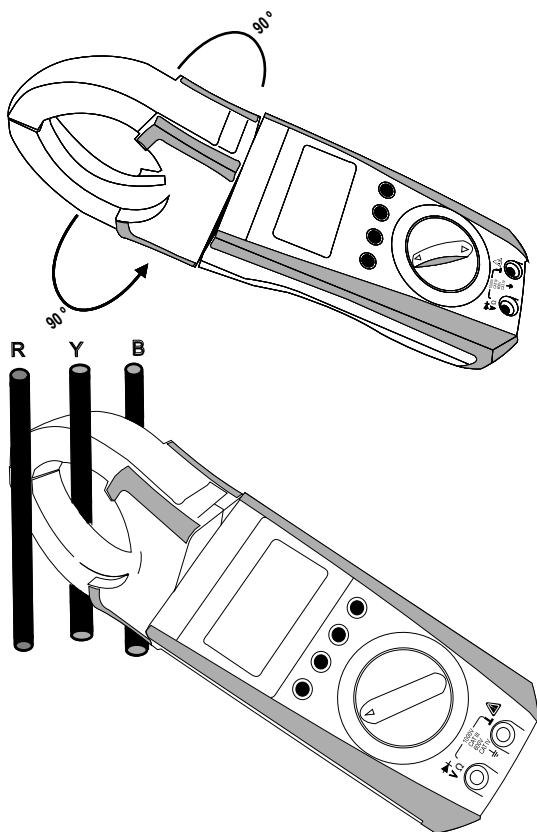

Figure 9.2

- For DC and ACDC current measurement mode , **Auto Zero adjustment** functionality is available for DC current up to + / - 5 A.
To make zero adjustment , long Press **HOLD** key on meter.
The meter acknowledge zero setting by a sound signal,

For AC Current mode following parameters are measured.

9.1 THD (Total Harmonic Distortion)

Power Clamp meter can measure THD up to 49th Harmonic.
By default meter is present on THD measurement screen.

$$\text{THD} = \sqrt{\frac{\sum_{n=2}^{49} (\text{n}^{\text{th}} \text{ order harmonic Current RMS value})^2}{(\text{Fundamental wave Current RMS value})^2}} \times 100 \%$$

9.2 DF (Distortion Factor)

Power Clamp Meter can measure DF up to 49th Harmonic.

$$DF = \sqrt{\frac{\sum_{n=2}^{49} (n^{\text{th}} \text{ order harmonic Current RMS value})^2}{(\text{Current RMS value})^2}} \times 100 \%$$

9.3 CF (Crest Factor)

Delta Power BT meter can measure CF. CF is the ratio between the value the peak current and corresponding RMS current.

$$CF = \frac{I_m (\text{Peak Current Value})}{I_{\text{RMS}} (\text{RMS Current Value})}$$

9.4 Peak Max / Peak Min

Peak Max /Min is the Positive / Negative peak value of measuring waveform. It updates continuously as per measuring waveforms peak.

9.5 Frequency

Delta Power BT meter measures frequency from 45 to 65 Hz.

9.6 Individual Harmonic measurement

Delta Power BT meter can measure individual harmonic current up to 49th Harmonic. Measured harmonic can also be seen in percent (%) w.r.t. fundamental current.

9.7 LPF measurement mode

Delta Power BT meter have LPF mode for current measurement. In LPF mode meter measures current below cutoff frequency. The cutoff frequency of clamp meter for LPF mode is 400 Hz. This means that meter will measure current having frequency below 400 Hz.

- ☛ Note : 1) If display shows OL then it indicates Current Overload. Overload. i.e. > 1020A
- ☛ To enter in LPF mode Simultaneously press “**yellow function key**” and “**Hold/Min/Max**” keys.



Figure 9.3

- Note :**
- 1) “----” is displayed for THD, DF, CF, Freq and Harmonics if current level is below measurement band or applied current is OL Value, 1020 A for Delta Power BT 1000A and 415 A for Delta Power BT 400A
 - 2) “----” is displayed for THD, DF and Harmonics if signal frequency is out of measuring band i.e. Freq Except 45Hz...65Hz
 - 3) In LPF mode meter will display 0 A if I < 1A
 - 4) For better accuracy of harmonic do not apply voltage at input terminal

Current measurement

Knob Position

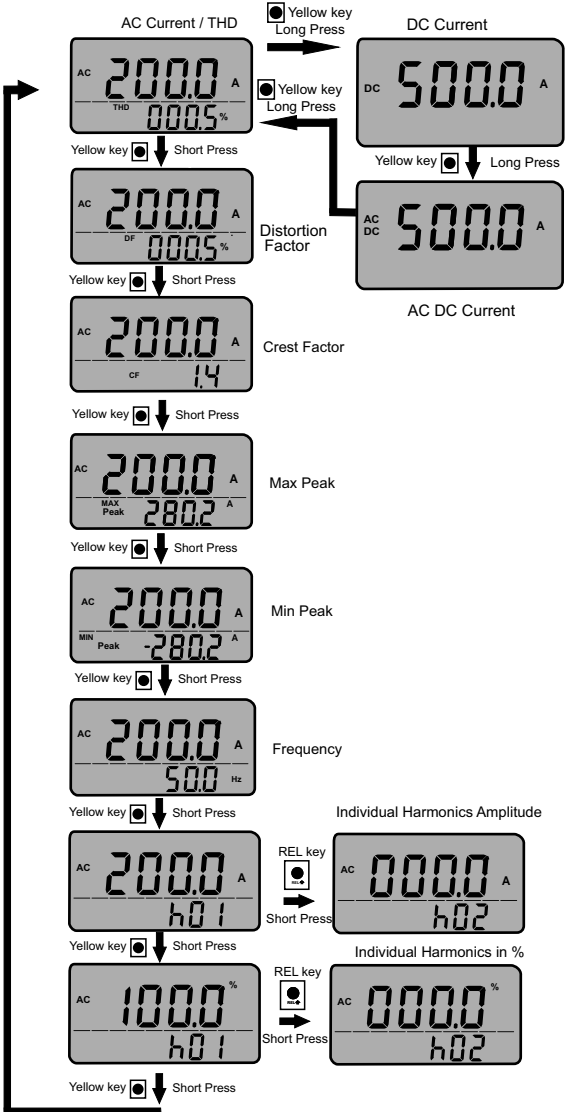

Fig 9.4 Current measurement screens

9.8 Inrush current measurement

Delta Power BT meter can measure AC Inrush current . This function allows us to easily measure inrush current that occurs when starting a motors Just clamp the clamp meter to line of motor and set meter in inrush mode before starting of motor so that after starting of motor meter will automatically measure and hold inrush Current value that occurred in 100 ms (measurement period) . Refer fig 9.5

Step1: Keep Knob Position on AAC



Step2: Clamp the meter around live conductor of motor

Step3: Press **INRUSH** key to set the meter in inrush mode
Now meter will wait for trigger to occur and display would look like

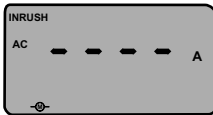

Step4: Start the motor. Clamp meter will be triggered by inrush current >5 A. Inrush current for 100 ms is measured.



Note: In harmonics screen INRUSH key is used to scroll harmonics
Inrush mode can not be activated in harmonics screen

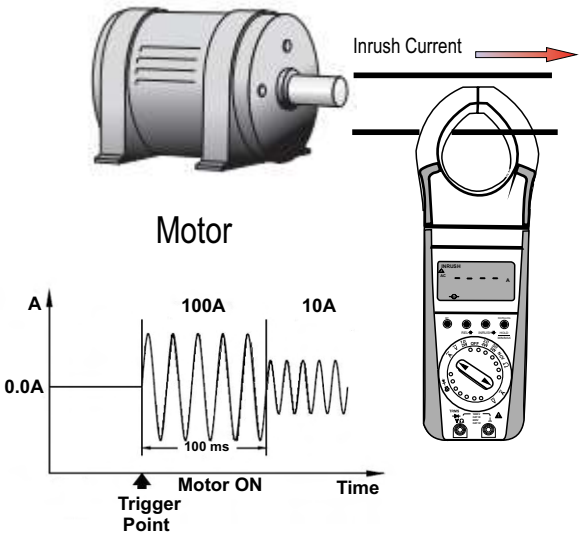

Fig 9.5

9.9 Ampere hour measurement

Delta Power BT Meter can measure Ahr for **AC and DC current** .

Clamp meter can accumulate Ahr for max time of 23:59 Hrs .

Maximum value of accumulated Ahr can be 999.9 Ahr . After

999.9 Ahr meter will display OL.

To measure Ahr go through following steps

Step1: Keep Knob position on AAC



Step2: For Ahr in AC current Press **REL and INRUSH** key simultaneously clamp meter will start measuring AC Ampere hours.



Note: For Ahr in **DC current**, long press (>2 Secs) yellow function key clamp meter enters In DC current mode. Now Press **REL and INRUSH** key simultaneously, clamp meter will start measuring DC Ampere hours.



10. Single Phase Power Measurement

- ☛ According to the single phase Power to be measured, set the function selector switch to $\frac{1}{2}\varnothing$ position.
- ☛ Connect the voltage test leads as shown in fig 10.2.
- ☛ Connect the Clamp as shown in fig. 10.2.
- ☛ Select the appropriate working mode i.e. AC or DC power by long pressing yellow key (function key).
- ☛ **For AC Power mode following parameters are measured.**

10.1 KVA , KW , KVAr (Apparent Power, Active Power , Reactive Power)

Delta Power BT Meter can measure KVA, KW and KVAr for single phase.

$$KVA = V * I$$

$$KW = V * I * \cos(\varnothing)$$

$$KVAr = V * I * \sin(\varnothing)$$

10.2 PF and \varnothing (Power Factor and phase angle)

Delta Power BT Meter can measure PF and \varnothing .

$$PF = KW / KVA$$

$$\varnothing = \cos^{-1} (PF)$$

10.3 hp (horse power)

Delta Power BT meter can measure Horse power (hp).

$$hp = KW / 0.7456$$

- ☛ **For DC Power mode following parameters are measured.**

10.4 DC Power (Active Power)

Delta Power BT Meter can measure DC KW for single phase.

$$KW = V * I$$

- ☛ For DC Power measurement mode , **Auto Zero adjustment** functionality is available. To make zero adjustment , long Press hold key on meter. The meter acknowledge zero setting by a sound signal, By Auto Zero Function maximum + / - 5 A DC can be nullified.

- ☛ Note :

- 1) If display shows OL.U then it indicates Voltage Overload.($>1020V$)
- 2) If display shows OL.I then it indicates Current Overload.($>1020A$) Overload.
- 3) If display shows OL then it indicates both current and voltage Overload.
- 4) If display shows +ve active power then the power flows from power source to load.
- 5) If display shows -ve active power then the power flows from load to power source.
- 6) If display shows +ve power factor then the phase of current is lagging behind the voltage (Inductive load).
- 7) If display shows -ve power factor then the phase of current is leading before the voltage (Capacitive load).
- 8) OL.U, OL.I and OL logic will remain same for 3P3W and 3P4W balanced system.

POWER Display Ranging For 1P2W, 3P3W and 3P4W

- ☛ For measurement of power total 4 Ranges are available 9.999 kVA, 99.99 kVA, 999.9kVA and 9999 kVA same applicable for hp, kVAr and kW.
- ☛ Meter will select range of all powers i.e. kW, hp and kVAr based on kVA reading.
For example :-
 $V = 230V, I = 102A$ and Angle = 0 then $kVA = 230 \times 102 = 23.46$ kVA
 $kW = 230 \times 102 \times \cos 0 = 23.46$ kW and $kVAr = 230 \times 102 \times \sin 0 = 0$ kVAr
So Meter will display power like 23.46 kW, 00.00 kVAr, 23.46 kVA
With same V & I now if Angle = 70 then,
 $kW = 230 \times 102 \times \cos 70 = 8.023$ kW and $kVAr = 230 \times 102 \times \sin 70 = 22.04$ kVAr
Now Meter will display kW like 8.02 and not 8.023 as kVA is in 99.99 range.
- ☛ hp Range is also based on kVA range except some cases where it is displayed one range higher than kVA.
For example :-
 $kVA = 82.53$ so at maximum value of $kW = kVA$ at PF = 1,
 $hp = kW / 0.7456 = 110.0$ so in this case hp is display in 999.9 range.
- ☛ 9.999 kVA range is only applicable for $V < 100$ V and $I < 100$ A.
- ☛ If $V > 500$ V and $I < 25$ A then, In this kind of situation a very small amount of current can cause a large amount of fluctuation in power reading.
To avoid this irritation of fast display fluctuation because of small current change meter will display power in 999.9 kVA range.
- ☛ All this ranging related logic is equally applicable for DC power (In DC POWER ranging is based on kW as there is no kVA), 3P4W balance as well as un balance and 3P3W balance as well as un balance system type.

Knob Position

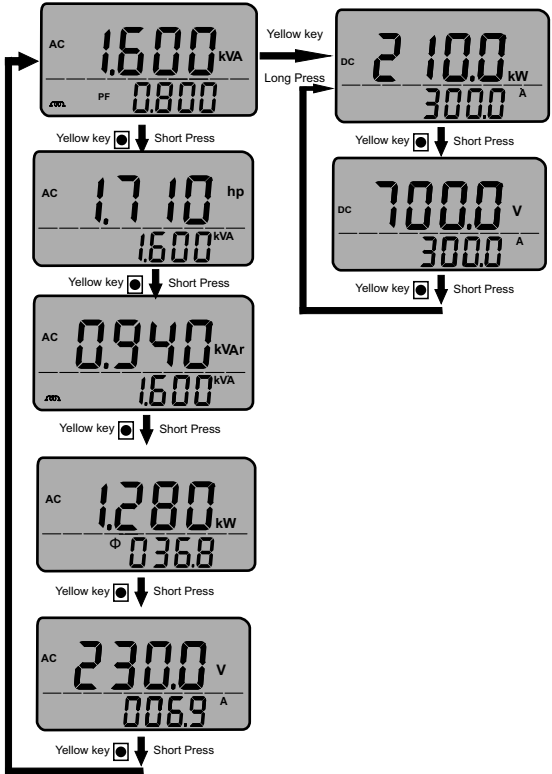
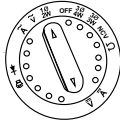

Fig 10.1 Power measurement screens

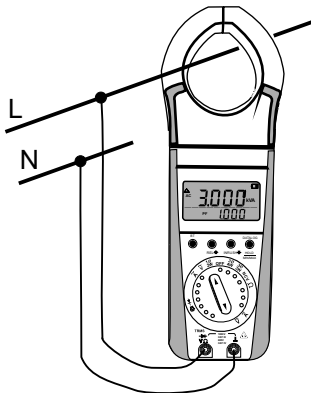

Fig 10.2 Connection diagram for 1P2W Power measurement

10.5 KWH Measurement in 1-phase 2-wire system

Delta Power BT meter accumulates **AC or DC power** to measure the energy up to 9999kWh. Beyond this limit it shows OL. Clamp meter can accumulate energy max up to 23.59 hrs. To measure Energy in AC power system follow the below steps

Step1: keep knob position as shown below



Step2: For kWh in AC Power Press **REL** and **INRUSH** key simultaneously clamp meter will start measuring kWh

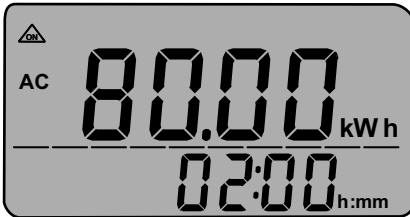

Note: For kWh in DC power system, long press (>2 Secs) yellow function key, clamp meter enters In DC power mode.

Now Press **REL** and **INRUSH** key simultaneously clamp meter will start measuring DC energy.

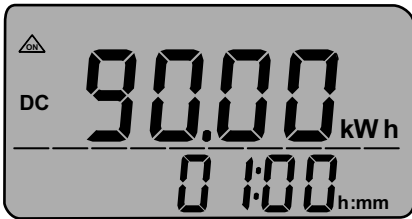

- 1) kWh Measurement is also possible in 3P3W and 3P4W balanced load by using simultaneous pressing **REL and INRUSH** key.
- 2) To reset energy measurement exit from energy mode and re enter into energy mode or restart the meter and enter into energy mode again.
- 3) If display shows -ve Energy then the power flows from load to power source.

11. 3-Phase 4- wire Power Measurement

- ☛ According to the 3 phase 4 wire Power to be measured, set the function selector switch to $\frac{3\phi}{4W}$ position.
- ☛ Using power Clamp meter, we can measure power of both balance and unbalance systems. After positioning of selector switch to $\frac{3\phi}{4W}$ position, meter will toggle between unbalance and balance system options using Up and Down keys. After pressing Yellow key, we can select any one type of system type and proceed for measurement.

☛ Note :

- 1) System Current and System Voltage readings will not be shown for unbalanced system(3P3W as well as 3P4W).
- 2) If display shows OL.U then it indicates Voltage Overload. (>1020 V)
- 3) If display shows OL.I then it indicates Current Overload. (>1020 A)
- 4) If display shows OL then it indicates both current and voltage Overload.
- 5) If display shows +ve active power then the power flows from power source to load.
- 6) If display shows -ve active power then the power flows from load to power source.
- 7) If display shows +ve power factor then the phase of current is lagging behind the voltage (Inductive load).
- 8) If display shows -ve power factor then the phase of current is leading before the voltage (Capacitive load).

11.1 3-Phase 4- wire unbalance Load Power Measurement

- ☛ Note that using single Power Clamp meter we can measure 3Ph power. Steps for measurement of 3 ph power are as follows.
 - 1) Configure Clamp meter to unbalance power measurement mode
 - 2) Meter will show L1-n and I -1 on display . Connect meter to phase L1 as shown in fig 11.1.2 (step 1).
 - 3) After connection press function (Yellow) key, meter will display measured apparent Power and PF for phase L1 on LCD.
 - 4) Wait for 5-10 sec so that measured value gets stable and then press function(Yellow) key to store readings of phase L1. After pressing function key meter will show L2-n and I-2 on display, which indicates that connect meter to phase L2.
 - 5) Now disconnect meter from phase L1 and connect to phase L2. Repeat Steps 2, 3 and 4 for phase L2 and L3.
 - 6) After storing readings of phase L3 , meter will show System apparent power and PF . At this point all measurements are finished. Now we can remove all input connections of meter and analyze all measured data.
 - 7) Measure data includes Active , Reactive, Apparent Power, Power Factor, Phase angle, horse power , voltage, Current. All these parameters are measured for individual phase and for system also. After step 6 if we press function (Yellow) key then we can scroll through all above measured parameter one by one . And if we press Up or Down key we can see measured data for individual phases (L1 or L2 or L3) and for system (Σ L123). Refer Fig 11.1.1
- ☛ **System Power (Σ L123) = L1 Power + L2 Power + L3 Power**

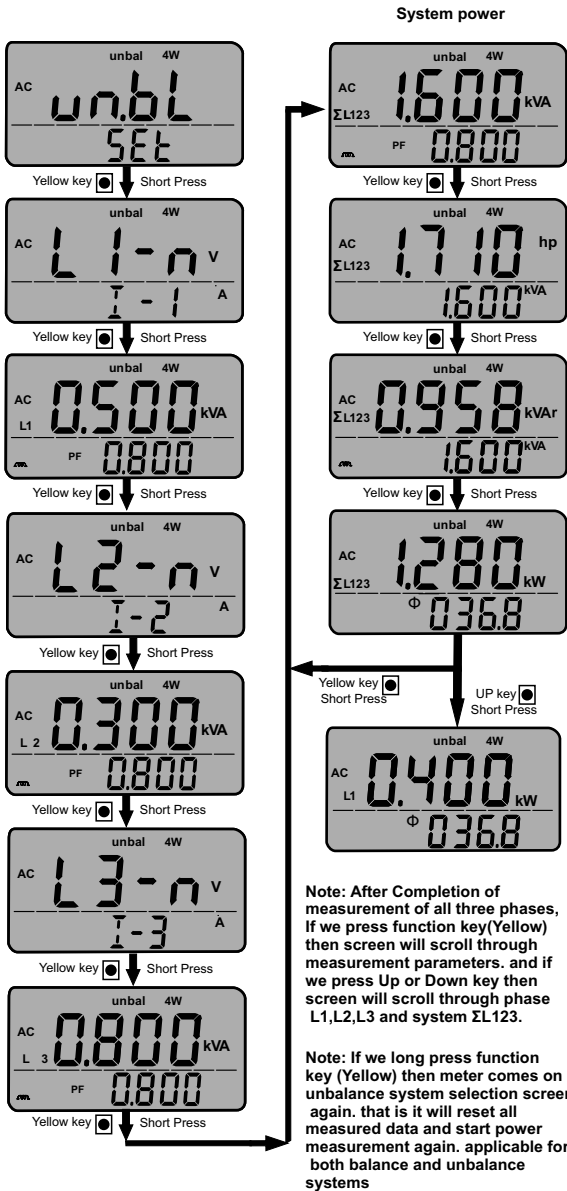

Fig 11.1.1 Power measurement 3-phase 4-wire Unbalanced load

Note :- In 3-phase 4-wire unbalanced system power measurement in every screen wait for the stable reading to store the reading without stabilization of power reading, if readings are stored by pressing yellow key then this can cause a false reading. If any phase voltage or any line current value is OL value then system power will be displayed as OL for 3P4W unbalanced system.

Keep Knob Position

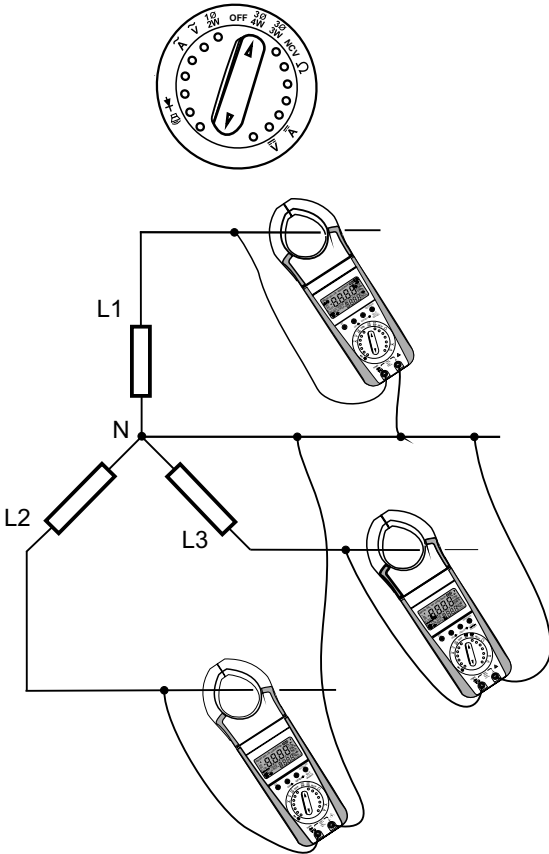

Fig 11.1.2 Connection diagram for 3ph4w unbalance load

11.2 3-Phase 4- wire balance Load Power Measurement

☛ In 3Ph balance load power measurement, we need to measure power 1 phase only. Steps for 1 ph power measurement are as follows.

- 1) Configure Clamp meter to balance power measurement mode
- 2) Meter will show L1-n and I -1 on display. Connect meter to phase 1 as shown in fig 11.2.1.
- 3) After connection press function (Yellow) key, meter will display measured apparent Power and PF on LCD.
- 4) In balance load, measured parameters updates continuously. Hold function can be used to hold all measured values. After hold we can remove all input connections of meter and analyze all data
- 5) Measure data includes Active, Reactive, Apparent Power, Power Factor, Phase angle, horse power, voltage, Current. All these parameters are measured for system ($\Sigma L123$) only.

If we press function (Yellow) key then we can scroll through all above measured parameter one by one. Refer Fig 11.2.2.

☛ **System Power ($\Sigma L123$) = L1 Power * 3**

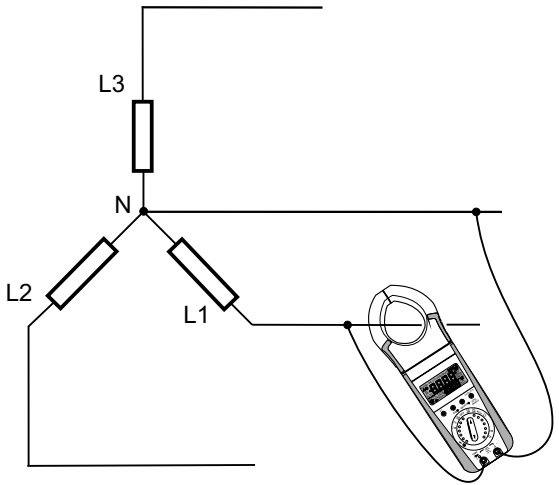

Fig 11.2.1 Connection diagram for 3ph4w balance load

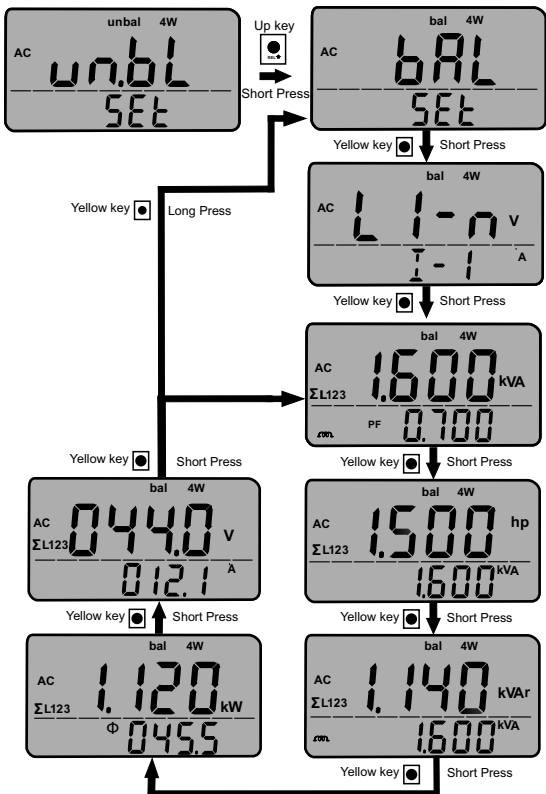

Fig 11.2.2 Power measurement 3-phase 4-wire balanced load

12. 3-Phase 3- wire Power Measurement

- ☛ According to the 3 phase 3 wire Power to be measured, set the function selector switch to $\frac{3\phi}{3W}$ position.
- ☛ Using Delta Power Clamp Meter, we can measure power of both balance and unbalance systems. After positioning of selector switch to $\frac{3\phi}{3W}$ position, meter will toggle between unbalance and balance system options using Up and Down keys. After pressing Yellow key, we can select any one type of system type and proceed for measurement.
- ☛ Note :
 - 1) System Current and System Voltage readings will not be shown for unbalanced system(3P3W as well as 3P4W).
 - 2) If display shows OL.U then it indicates Voltage Overload. (>1020 V)
 - 3) If display shows OL.I then it indicates Current Overload. (>1020 A)
 - 4) If display shows OL then it indicates both current and voltage Overload.
 - 5) If display shows +ve active power then the power flows from power source to load.
 - 6) If display shows -ve active power then the power flows from load to power source.
 - 7) If display shows +ve power factor then the phase of current is lagging behind the voltage (Inductive load).
 - 8) If display shows -ve power factor then the phase of current is leading before the voltage (Capacitive load).

12.1 3-Phase 3- wire unbalance Load Power Measurement

- ☛ Note that using single Power Clamp Meter we can measure 3Ph power. Steps for measurement of 3 ph power are as follows.
 - 1) Configure Clamp meter to unbalance power measurement mode
 - 2) Meter will show L1-2 and I -1 on display. Now connect meter to phase 1 as shown in fig 12.1.2.
 - 3) After connection press function (Yellow) key, meter will display measured apparent Power and PF of phase 1-2 on LCD.
 - 4) Wait for 5-10 sec so that measured value gets stable and then press function (Yellow) key to store readings of phase 1-2. After pressing function key meter will show L3-2 and I-3 on display, which indicates that connect meter to phase 3-2
 - 5) Now disconnect meter from phase 1-2 and connect to phase 3-2. Repeat Step 2, 3 and 4 for phase 3-2.
 - 6) After storing readings of phase 3-2, meter will show System apparent power and PF. At this point all measurements are finished. Now we can remove all input connections of meter and analyze all measured data.
 - 7) Measure data includes Active, Reactive, Apparent Power, Power Factor, Phase angle, horse power. All these parameters are measured for phase 1-2, phase 3-2 and for system (Σ L123). After step 6 if we press function (Yellow) key then we can scroll through all above measured parameter one by one. And if we press Up or Down key we can see measured data for phase1-2, phase 3-2 and for system (Σ L123). Refer Fig 12.1.1
- ☛ **System Power (Σ L123) = L1-2 Power + L2-3 Power**

Keep Knob Position

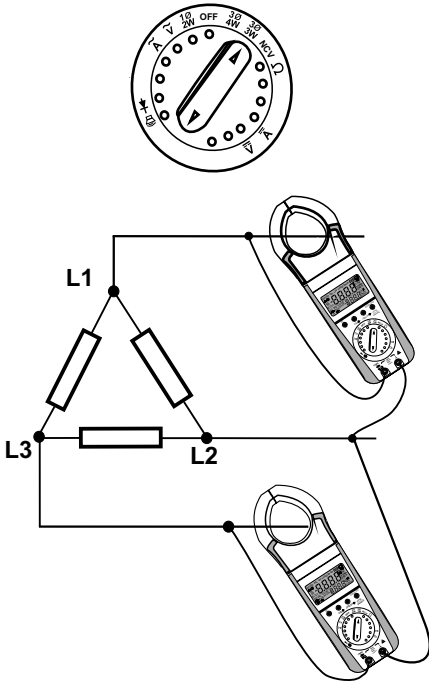

Fig 12.1.2 Connection diagram for 3ph3w unbalance load

12.2 3-Phase 3- wire balance Load Power Measurement

- In 3Ph balance load power measurement, we need to measure power 1-2 phase only. Steps for 1-2 ph power measurement are as follows.
 - 1) Configure Clamp meter to balance power measurement mode
 - 2) Meter will show L1-2 and I-1 on display. Connect meter to phase 1-2 as shown in fig 12.2.1.
 - 3) After connection press function (Yellow) key, meter will display measured apparent Power and PF on LCD.
 - 4) In balance load, measured parameters updates continuously. Hold function can be used to hold all measured values. After hold we can remove all input connections of meter and analyze all data
 - 5) Measure data includes Active, Reactive, Apparent Power, Power Factor, Phase angle, horse power, voltage, Current. All these parameters are measured for system ($\Sigma L123$) only.
If we press function (Yellow) key then we can scroll through all above measured parameter one by one. Refer Fig 12.2.2
- **System Power ($\Sigma L123$) = VL1-2 * I1 * 1.732**

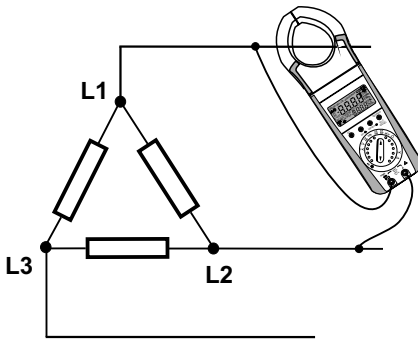

Fig 12.2.1 Connection diagram for 3ph3w balance load

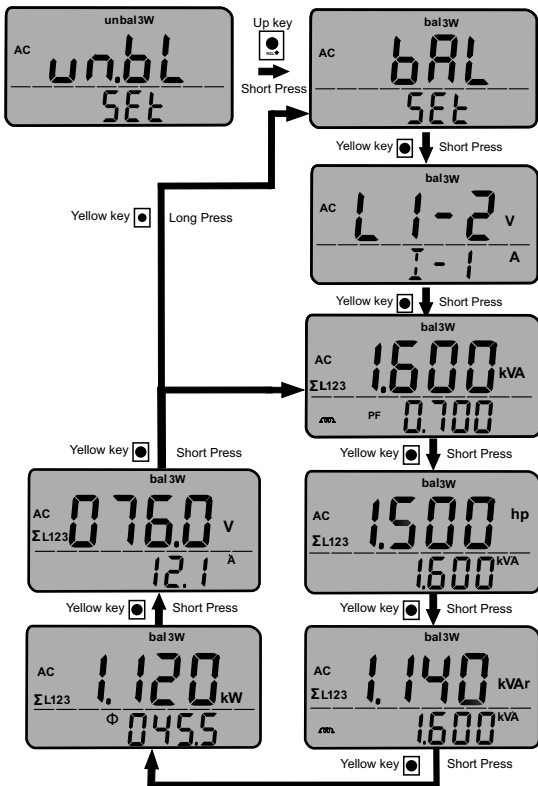

Fig 12.2.2 Power measurement 3-phase 3-wire balanced load

13. NCV Detection (Non Contact Voltage Detection)

- ☛ For NCV detection mode place selector switch to NCV position..
- ☛ NCV allows detection of AC voltage from >100 V 50/60 Hz.
- ☛ For NCV detection, touch the left jaw to voltage carrying conductor Presence of voltage will be indicated by buzzer sound along with backlit blinking

Note :- Even if voltage presence is not detected do not touch bare wire or cable.

14. Resistance, Continuity and Diode measurement



Attention!

Verify that the device under test is electrically dead. External voltages would falsify the measurement results!

- ☛ For Resistance or continuity or diode measurement place function selector switch to Ω position .
- ☛ For Resistance and continuity measurement connect DUT as shown bellow

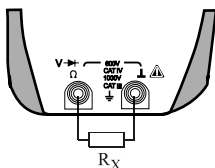

The clamp meter can measure resistance up to 9999 ohm . For continuity measurement , meter will generate continuous beep sound if measured resistance is from 0 to 40 ohm approx.

- ☛ For Diode measurement connect DUT as shown bellow

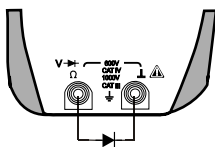

The measuring instrument displays forward voltage in volts. As long as voltage drop does not exceeds the maximum display value of 2.2V, we can test several instruments in series.

OL will be displayed on display when diode is connected in reverse bias.



Note!

Resistors and semiconductor paths in parallel to the diode distort the measurement results!

15.Empty Positions

Empty positions on dial indicates no function is available on these positions.The digital display will look like as in figure below.

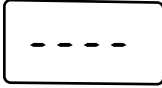

16. Data logging mode

To Enter into Data logging mode Press DATALOG key and simultaneously turn ON meter. Now meter is in the data logging mode and you can see a data logging menu as shown in fig15.1

When meter is already in data logging mode, long press DATALOG key to enter into data logging menu.

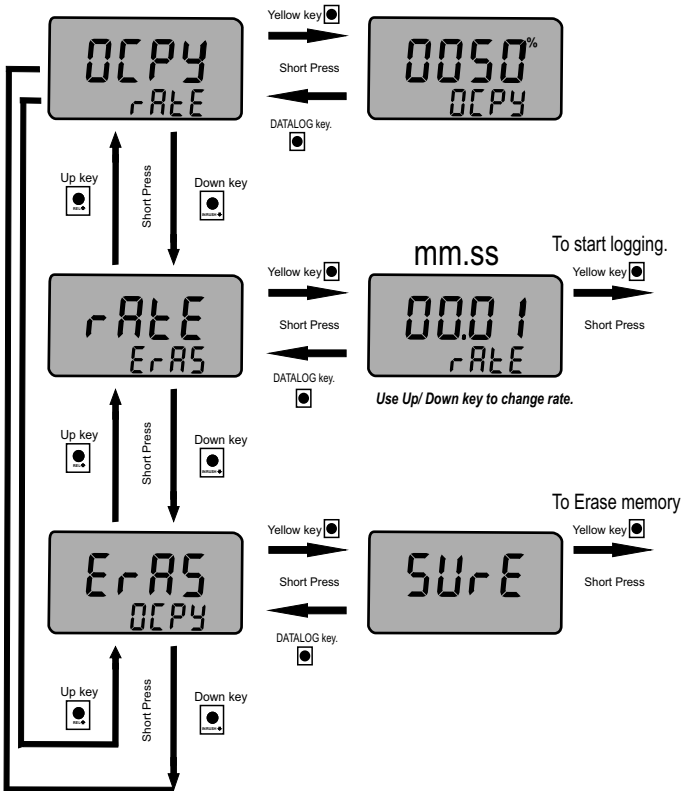

Fig 15.1 Data logging menu

User can select data logging rate as

mm.ss	mm.ss
00.01 = 1sec	05.00 = 5min
00.02 = 2sec	10.00 = 10min
00.05 = 5sec	20.00 = 20min
00.10 = 10sec	30.00 = 30min
00.30 = 30sec	50.00 = 50min
01.00 = 1min	60.00 = 60min
02.00 = 2min	

While the data logging is ongoing Δ symbol blinks.

To stop data logging long press datalog key and the following menu will display on screen.

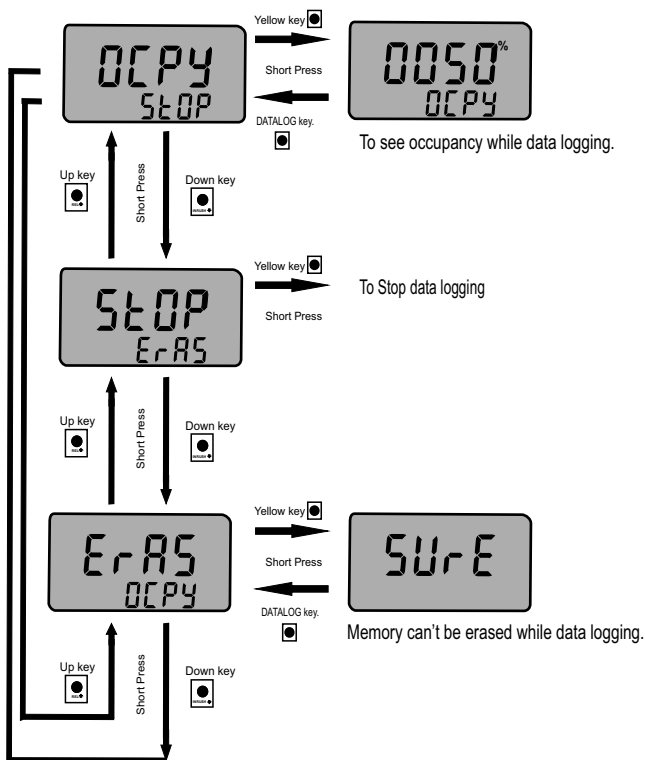

Fig 15.2. Data logging menu (while data logging is started)

When there is no space for data logging and we turn on meter into Data logging mode a FULL message will display on screen.



Note :

1. During data logging if function on meter is changed it will create a new file for the new function and save previous readings in another file.
2. Data logging menu is absent in DC current, ACDC current and DC power. To log this parameters, first start data logging in another function and then come into this function without terminating data logging.
3. Before turning OFF the meter stop the data logging properly to avoid data corruption.
4. During Datalogging when memory becomes FULL, Data logging will get stopped automatically and Δ symbol will stop blinking.

17. Bluetooth connection

To connect meter with PC or android phone, meter should be in discoverable mode.

To enter into discoverable mode press BT key \blacksquare and simultaneously turn ON the clamp meter. When meter goes into discoverable mode ON symbol Δ starts blinking. Wait for approx. 20sec and then establish communication through software or mobile application.

Download and install the mobile application (PCM Connect) on your phone from google play store.
Then turn ON Bluetooth on your phone and pair your device from the list of available devices using a pairing key (1234).
Once the device is paired with your phone open the PCM Connect application.
Then press the button as shown in figure.

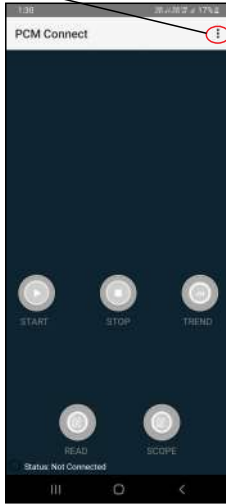

Then in the Drop down menu press Scan button.



Then select your device from the Bluetooth devices list.

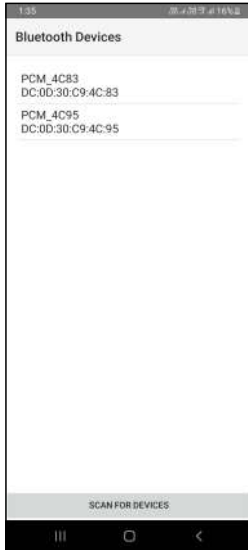

NOTE : If your Device is not shown in Bluetooth Devices list then
1) *Press Scan for Devices button to refresh the list.*
2) *Make sure that your device is paired with your phone bluetooth.*

On successful connection with the meter the following screen will be display and the meter is now connected to your phone.

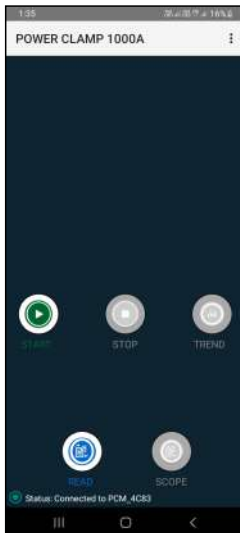

18. Specifications

Reference Conditions

Ambient temperature :	+ 23 °C ±2K
Relative humidity:	45%... 55 % RH
Frequency of measured quantity	50Hz or 60 Hz
Power factor	0.5L...1....0.5C
Waveform of the measured quantity	Sinusoidal
Battery voltage	8V ±0.1V

Technical Specification

Measuring function	Measuring range	Resolution	Intrinsic error of digital display at reference condition	
VDC	999.9 V	0.1 V	±(0.5% of rdg + 5 dgt)	
V~	999.9 V	0.1 V	±(0.75% of rdg+5 dgt)	
VACDC	999.9 V	0.1 V	±(1.25% of rdg+10dgt)	
LPF V~	999.9 V	0.1 V	50.....60 Hz	±(0.75% of rdg + 5dgt)
			61...400Hz	±(5.0% of rdg + 5dgt)
DELTA POWER CLAMP 1000A ADC-AAC	999.9A	0.1 A	±(1.5% of rdg+5 dgt) ¹⁾	
DELTA POWER CLAMP 400A ADC - AAC	99.99 A	0.01 A	display value <1000 add 10 dgt	±(1.5% of rdg+0.2A) ¹⁾
	400 A	0.1 A	±(1.5% of rdg+5 dgt) ¹⁾	
DELTA POWER CLAMP 1000A A ACDC	999.9A	0.1 A	±(3% of rdg+10 dgt) ¹⁾	
DELTA POWER CLAMP 400A A ACDC	99.99 A	0.01 A	display value <1000 add 10 dgt	±(3% of rdg+0.4A) ¹⁾
	400 A	0.1 A	±(3% of rdg+10 dgt) ¹⁾	
DELTA POWER CLAMP LPF 1000A AAC	999.9A	0.1 A	50.....60 Hz	±(1.5% of rdg + 5dgt)
			61...400Hz	±(5.0% of rdg + 5dgt)
DELTA POWER CLAMP LPF 400A AAC	99.99 A	0.01 A	50.....60 Hz	±(1.5% of rdg + 0.3A)
	400 A	0.1 A	61...400Hz	±(5.0% of rdg + 5dgt)
Active Power ²⁾	9.999 kW	1 W	±(2% of rdg+5 dgt) ¹⁾	
	99.99 kW	10 W		
	999.9 kW	100 W		
	9999 kW	1 kW		
Reactive Power ²⁾	9.999 kVAr	1 VAr		
	99.99 kVAr	10 VAr		
	999.9 kVAr	100 VAr		
	9999 kVAr	1 kVAr		
Apparent Power ²⁾	9.999 kVA	1 VA		
	99.99 kVA	10 VA		
	999.9 kVA	100 VA		
	9999 kVA	1 kVA		
Horse Power ²⁾	9.999 hp	0.001 hp		
	99.99 hp	0.01 hp		
	999.9 hp	0.1 hp		
	9999 hp	1 hp		

Technical Specification

Measuring function	Measuring range	Resolution	Intrinsic error of digital display at reference condition
kWh ²⁾	9.999 kWh	0.001 kWh	±(3% of rdg+5 dgt)
	99.99 kWh	0.01kWh	
	999.9 kWh	0.1 kWh	
	9999 kWh	1 kWh	
Ahr	999.9 Ahr	0.1 Ahr	
Phase angle ²⁾	0.0°...360.0°	0.1°	±3°
Power Factor ²⁾	-1...0...1	0.001	
Harmonics (RMS & %) ³⁾	1...13	0.1V 0.1A	±(3% of rdg+10 dgt)
	14...49	0.1%	±(5% of rdg+20 dgt)
THD ³⁾	0...99.9%	0.1%	±(3% of rdg+20 dgt)
DF ³⁾	0...99.9%	0.1%	±(3% of rdg+20 dgt)
Crest Factor ³⁾	1.0...2.9	0.1	±(2% of rdg+3 dgt)
	3.0...5.0	0.1	±(3% of rdg+5 dgt)
POWER CLAMP 1000A Peak	1400 A / 1400V	1 A	±(3% of rdg+3 dgt)
POWER CLAMP 400A Peak	100 A	0.1 A	±(3% of rdg+10 dgt)
	560 A / 1000 V	1 A / 1 V	±(3% of rdg+3 dgt)
POWER CLAMP 1000A INRUSH ⁴⁾	999.9A	0.1 A	±(3% of rdg+5 dgt)
POWER CLAMP 400A INRUSH ⁴⁾	99.99 A	0.01 A	±(3% of rdg+0.3A)
	400 A	0.1 A	±(3% of rdg+5 dgt)
Resistance	9999 Ohm	1 Ohm	±(0.5% of rdg+5 dgt)
Continuity	Below 40 Ohm	1 Ohm	±(0.5% of rdg+5 dgt)
Diode	0...2.2V	0.001 V	±(0.5% of rdg+5 dgt)

Note:- Accuracy claimed for Power and Current when conductor is positioned at the center of the jaw.

1) For DC A make auto zero correction by long pressing the **HOLD** key

For Delta Power BT 1000A

2) Accuracy Defined for $V \geq 10V$ and $I \geq 5A$

Add 10 digit to accuracy when power is $< 5.000 \text{ kW} / \text{kVA} / \text{kVAr}$ or $< 6.700 \text{ hp}$

3) Accuracy Defined for $V \geq 10V$ and $I \geq 10A$

4) Accuracy Defined for $I \geq 10A$

For Delta Power BT 400A

2) Accuracy Defined for $V \geq 10V$ and $I \geq 4A$

Add 10 digit to accuracy when power is $< 5.000 \text{ kW} / \text{kVA} / \text{kVAr}$ or $< 6.700 \text{ hp}$

3) Accuracy Defined for $V \geq 10V$ and $I \geq 10A$

4) Accuracy Defined for $I \geq 5A$

For Delta Power BT 1000A

- In 1P2W mode maximum power meter can measure is, 1000 kVA / 1000 kVAr / 1000 kW / 1341 hp
- In 3P4W mode maximum power meter can measure is, 3000 kVA / 3000 kVAr / 3000 kW / 4023 hp
- In 3P3W mode maximum power meter can measure is, 1732 kVA / 1732 kVAr / 1732 kW / 2322 hp

For Delta Power BT 400A

- In 1P2W mode maximum power meter can measure is, 400 kVA / 400 kVAr / 400 kW / 536 hp
- In 3P4W mode maximum power meter can measure is, 1200 kVA / 1200 kVAr / 1200 kW / 1608 hp
- In 3P3W mode maximum power meter can measure is, 693 kVA / 693 kVAr / 693 kW / 928 hp

Over Load Capacity

Measuring function	Measuring range	Over load capacity	
		Over load value	Overload duration
VDC - VAC - VACDC	999.9 V	1000 V DC/AC	Continuously
Delta POWER CLAMP 1000A ADC - AAC - AACDC	999.9A	1100 A AC/DC	
Delta POWER CLAMP 400A ADC - AAC - AACDC	99.99 A	440A AC/DC	
	400 A		
Active Power Reactive Power Apparent Power Horse Power kWh	9.999 kW/ kVA/ kVAr/ hp/ kWh	1000 V DC/AC 1100 A AC/DC for Delta Power Clamp 1000A 440 A AC/DC for Delta Power Clamp 400A	
	99.99 kW/ kVA/ kVAr/ hp/ kWh		
	999.9 kW/ kVA/ kVAr/ hp/ kWh		
	999.9 kW/ kVA/ kVAr/ hp/ kWh		
Ahr	999.9 Ahr		Continuously
Inrush	1000 A / 400A		Continuously
Resistance / Continuity	9999 Ohm	1000 V DC/AC eff/rms Sine wave	10 Secs
Diode	2.2 V		

Influence quantity and variations

Influence quantity	Range of Influence	Measured quantity / Measuring Range	Variation
Temperature	0 °C... 21 °C and 25 °C.....50 °C	VAC	0.15 X Intrinsic Error / °C
		VDC	
		VACDC	
		AAC	
		ADC	
		AACDC	
		AC Power	
		DC Power	
Frequency of the measured quantity	40 Hz... 50 Hz and 60 Hz...400 Hz 45 Hz.....65 Hz ²⁾	VAC	1 X Intrinsic Error
		VACDC	
		AAC	
		AACDC	
Crest Factor ¹⁾	1.4...2	VAC	1% + Intrinsic Error
	2...2.5	AAC	2.5% + Intrinsic Error
	2.5...5		4% + Intrinsic Error
Supply Voltage	When Low Battery symbol is ON	All Ranges	1 X Intrinsic Error
Relative humidity	75%	All Ranges	1 X Intrinsic Error

1) Except Sine Wave

CF 2 @ 690V, 690A for Delta Power Clamp Meter 1000 AACDC
 CF 2 @ 690V, 280A for Delta Power Clamp Meter 400 AACDC
 CF 3 @ 460V, 460A for Delta Power Clamp Meter 1000 AACDC
 CF 3 @ 690V, 186A for Delta Power Clamp Meter 400 AACDC
 CF 4 @ 345V, 345A for Delta Power Clamp Meter 1000 AACDC
 CF 4 @ 345V, 140A for Delta Power Clamp Meter 400 AACDC
 CF 5 @ 280V, 280A for Delta Power Clamp Meter 1000 AACDC
 CF 5 @ 280V, 112A for Delta Power Clamp Meter 400 AACDC

2) Except for 50 or 60 Hz

Digital Display :

Display	Seven Segment Display
Character Height	Main Display character : 11.5 mm Sub Display character : 7.2 mm
Number of digits	4 digits
Maximum Count	9999 counts for V, I, P and Resistance
Over range Indication	"OL" is displayed.
Polarity indication	" - " sign is displayed for negative values.

Power supply

Battery	9V flat cell battery , manganese-di oxide cell according to IEC6F22, alkaline-manganese cell according to IEC6LR61
Consumption	14 mA average (without backlight and without bluetooth)
Battery life	Approx 48 Hrs (without bluetooth) Approx 10 Hrs (with bluetooth)

Electrical Safety:

As per IEC 61010-1 2010

Measuring Category	III	IV
	1000V	600V
Pollution Degree	2	
High Voltage (HV)	7.4 kV	between housing and input
	4.26 kV	between housing with jaws and input
Ingress Protection	IP 50	for housing
	IP 20	for terminal

EMC

Emission	Electromagnetic compatibility IEC61326: 2020 ClassB	
Immunity	IEC61326: 2020	
	IEC61000-4-2	8 kV Air discharge 4kV contact discharge
	IEC61000-4-3	3V/m

Environmental Conditions

Operating temperature range	0 to +55° C
Storage temperature Range	-20° C...+70° C
Relative humidity	0 to 75 % non condensing
Altitude	up to 2000m

Mechanical configuration

Dimensions	90mm(W)x270mm(L)x70mm(H)
Weight	500gm approx., including battery

19. Maintenance

Caution

Disconnect the meter from the measuring circuit before you open it to replace the battery !

19.1. Battery

Prior to initial start-up, or after storage of power clamp meter, verify that the battery of power clamp meter does not leak. Repeat this check in regular short intervals. If the battery leaks, completely remove the battery electrolyte carefully with a moist cloth and install a new battery before you operate power clamp meter again.

When the symbol "  " is ON (Battery Voltage < 6.5 V) on the LCD replace the battery as soon as possible. Measurement can be done, but a reduced measuring accuracy must be taken into account. " **bAtt** " will be displayed on LCD when battery voltage drops below 5 V, after that measurement is not possible with meter.

The Power clamp meter operates with a 9V flat cell battery according to IEC6F22 or IEC6LR61 or with a suitable NiCd storage battery .



Attention!

Disconnect the instrument from the measuring circuit before opening battery cover to replace the batteries.

Replacing the battery

- Place the power clamp meter on its face. Loosen the screw of battery cover. Which is at rear bottom side of meter. Remove battery cover by Sliding It to bottom side.
- Remove the battery from the battery compartment and carefully disconnect battery connectors.
- Snap the battery connectors to a new 9 V battery and insert the battery into the battery compartment.
- Replace the battery cover by fitting it into slots on battery compartment
- Tighten the battery cover with the screw.
Please destroy the battery in an environment friendly way .

19.2. Periodic Check-up:

The power clamp meter does not require any specific maintenance. The surface between opening jaws should be cleaned with dry cloth before operating. Avoid use of cleansers, abrasives or solvents.

20. Servicing

When you need service, refer the cover page for company address.

WARRANTY

Dear Customer,

You are now the privileged owner of Digital Delta Power Clamp meter / Accessories, a product that ranks the first of its kind in the world.

Company provides 12 months warranty from the original date of purchase against defective material and workmanship.

In the unlikely event of failure of this meter / accessories within the warranty period, Company will repair the meter / accessories free of charges. Please hand over the meter / accessories to the dealer / Stockiest from whom you have purchased along with this card and relevant cash memo / Invoice. This warranty entitles you to bring the meter / accessories at your cost to the nearest stockiest / dealer and collect it after repairs.

NO TRANSPORTATION CHARGES WILL BE REIMBURSED

The warranty is not valid in following cases:

- 1) Warranty card duly signed / stamped and original cash memo / invoice are not sent along with the meter / accessories.
- 2) Complete warranty card is not presented to authorized person at the time of repairs.
- 3) Meter / accessories not used as per the instruction in the user manual.
- 4) Defect caused by misuse, negligence, accidents, tampering and acts of god.
- 5) Improper repairing by any person not authorized by the company.
- 6) Any sort of modification, alteration is made in electrical circuitry.
- 7) Seal provided inside is broken.

Warranty of Digital Clamp meter / Accessories does not cover fuses and battery. In case of dispute to the validity of warranty, the decision of Company's service center will be final.

If you bought this meter / accessories directly from the company, and if you notice transit Damage, then you must obtain the insurance surveyors report and forward it to Company. Thank you.

(To be filled by authorized dealer)

Model No. : _____

Serial Number : _____

Date of Purchase : _____

Cash Memo / Invoice No. : _____

Dealer's Signature : _____

Dealer's Stamp : _____

Scope of Supply:	1) Meter	2) Cable set	
	3) Battery	4) User Manual	
	5) Warranty Card	6) Test Certificate	
	7) Carrying Case	8) Crocodile Clips	

Sifam Tinsley Instrumentation Inc.

3105 Creekside Village Drive, Suite No. 801, Kennesaw, GA 30144 (USA)

Contact No. : +1 404 736 4903

E-mail Id : psk@sifamtinsley.com

Web : www.sifamtinsley.com
