

# Operating Manual

## Temperature Controller RE 57 , RE 77 & RE 96



## Read & understand this manual before using the instrument



The proper and safe operation of device assumes that the operating instructions are read and the safety warnings given in the various section mounting ,electrical connection, commissioning are observed.



All operations concerning installation, electrical connection, commissioning must be carried out by qualified, skilled person and national regulations for prevention of accidents must be observed.

# Temperature Controller

## INDEX

<b>Section</b>	<b>Contents</b>
1.	Introduction
2.	Scope of delivery
3.	Accessories
4.	Installation
	4.1 EMC Installation Requirements
	4.2 Case Dimension & Panel Cut Out
	4.3 Wiring
	4.4 Auxiliary Supply
	4.5 Fusing
	4.6 Earth / Ground Connection
5.	Connection Diagrams
6.	Programming
	6.1 Setpoint Programming
	6.2 Setup Parameter Programming
	6.3 Cancel Change of Value
	6.4 Menu Exit
	6.5 Setup Screens
	6.6 Service Parameter
	6.7 Setup Parameters
7.	Controller Input and Output
	7.1 Measuring Input
	7.2 Outputs
8.	Control Algorithm
	8.1 ON-OFF Algorithm
	8.2 PID Algorithm
	8.2.1 Self Tuning (Auto Tuning)
	8.2.2 Tuning of PID parameter in case of a dissatisfying control

- 9. Alarms
- 10. Timer Function
  - 10.1 Tolerance Band (t.band)
  - 10.2 Timer Functions (timr)
- 11. Additional Functions
  - 11.1 Control Signal Monitoring
  - 11.2 Manual Control
  - 11.3 Digital Filter
- 12. Factory Reset Function
- 13. Technical Data

## 1. Introduction

The RE series controller is used for temperature control in plastics, food & dehydration industries where the temperature stabilization is necessary. It has universal inputs like RTD sensors , Thermocouple sensors & standard linear signals like voltage /current.

The controller has two 7 segment displays for seperate indication of process value (PV) and the setpoint (SP) with proper annunciation of output/alarm signal as well as the mode of the controller.

RE series provides PID & ON/OFF control algorithm as well as different types of alarm .It has two outputs which can be configured for control as well as for alarm or both can be configured as alarm.

The meter can be configured onsite though use of front keys as well as through the USB (using PRKAB) . The front panel has has three keys for user interface.

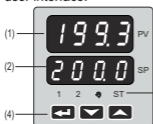

- (1) – 7 Segment display (Process value)  
Four digit ,Red, Decimal point configurable also used for operator prompting(display of setup menu)
- (2) – 7 Segment display (Setpoint value)  
four-digit, Green; also used for display of other features and setup parameter values in setup)

### (3) – Indications

- 1 – output 1 status ,  
♦ – Manual mode ,

- 2 – Output 2 status,  
ST – Self tuning

### (4) – Keys

Configuration of setup parameter & scrolling through additional features

## 2. Scope of delivery

- Controller
- Terminal Protection Cap
- Swivel Clips (02 nos)
- Operating Manual
- Interface definition

## 3. Accessories

**USB Interface:**PC interface with PRKAB converter and USB cable for configuration of meter. This has to be order separately.

## 4. Installation

### A) RE57

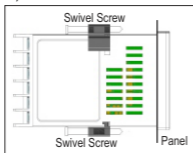

### B) RE77

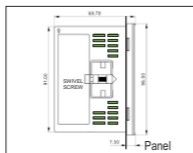

### C) RE96

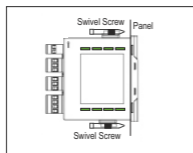

## Caution:

In the interest of safety and functionality this product must be installed by a qualified engineer, abiding by any local regulations. Voltages dangerous to human life are present at some of the terminal connections of this unit. Ensure that all supplies are de-energised before attempting any connection or disconnection. These products do not have internal fuses therefore external fuses must be used to ensure safety under fault conditions.

Push the meter in panel slot (size 45 x 45 mm , 45 x 92 & 92x92) for RE57, RE77 & RE96 respectively. Mount the meter with the help of provided swivel screws as shown in figure.

The front of the enclosure conforms to IP54. Additional protection to the panel may be obtained by the use of an Optional panel gasket. The terminals at the rear of the product should be protected from liquids.

The Controller should be mounted in a reasonably stable ambient temperature and where the operating temperature is within the range -20° to 70° C. Vibration should be kept to a minimum and the product should not be mounted where it will be subjected to excess of sunlight.

#### 4.1. EMC Installation Requirements

This product has been designed to meet the certification of the EU directives when installed to a good code of practice for EMC in industrial environments, e.g.

1. Screened output and low signal input leads or have provision for fitting RF suppression components, such as ferrite absorbers, line filters etc., in the event that RF fields cause problems.

Note: It is good practice to install sensitive electronic instruments that are performing critical functions, in EMC enclosures that protect against electrical interference which could cause a disturbance in function.

2. Avoid routing leads alongside cables and products that are, or could be, a source of interference.

3. To protect the product against permanent damage, surge transients must be limited to 2kV pk. It is good EMC practice to suppress differential surges to 2kV at the source. The unit has been designed to automatically recover in the event of a high level of transients. In extreme circumstances it may be necessary to temporarily disconnect the auxiliary supply for a period of greater than 5 seconds to restore correct operation.

4. ESD precautions must be taken at all times when handling this product.

#### 4.2. Case Dimension & Panel Cut Out

##### A) RE57

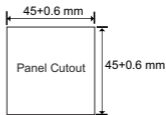
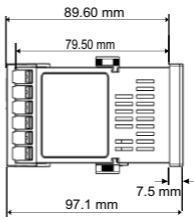
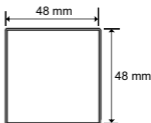

## B) RE 77

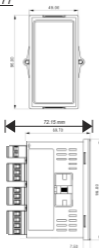

## C) RE 96

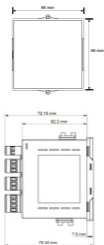

## 4.3.Wiring

Input connections are made directly to screw-type terminals with indirect wire pressure. Numbering is clearly marked on the connector. Choice of cable should meet local regulations.

**Note: It is recommended to use wire with lug for connection with meter.**

## 4.4. Auxiliary Supply

Meter should ideally be powered from a dedicated supply, however powered from the signal source, provided the source remains within it may be the limits of the chosen auxiliary voltage range. A switch or circuit may be used in closed proximity to the equipment and within easy reach of operator. Disconnecting device used must meet the IEC-60947-1 and IEC-60947-3 requirement.

## 4.5.Fusing

It is recommended that all voltage lines are fitted with 1A HRC fuses.

## 4.6 Earth/ Ground Connection

For safety reason, ensure proper grounding of panel.



## 5. Connection Diagrams

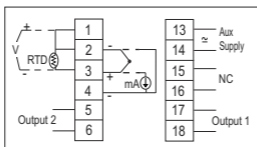

### Input Signals

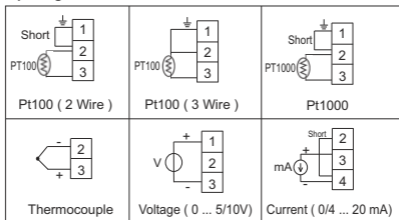

### Output Signals

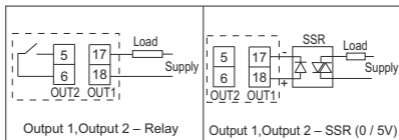

## 6. Programming

### 6. 1. Setpoint Programming



In main display screen, press Up key or Down Key to enter into setpoint edit mode.



When setpoint edit mode is enable, last digit decimal point start blinking. Use Up key and Down key to scroll the value.



Press Enter key to confirmation setpoint value.

**Note: Setpoint Inhibit function needs to be disable while programming of setpoint through display.**

### 6. 2. Setup Parameter Programming :



In main display screen, press & hold Enter key for approx. 5 sec to enter into setup edit mode.

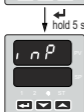

If setup is password protected, user has to enter the correct password to enter into the setup edit mode. With entry of incorrect password, user can only read the setup parameter values(editing is prohibited) then setup menu is appear on the display.



Use Up Key & Down Key to scroll through different setup menu parameter.



To enter into the sub-menu of display menu , press Enter key.

Use Up Key & Down Key to scroll through different sub-menu parameter.



Press Enter key to edit the value of submenu parameter value. value will start blinking in edit mode. Use Up Key & Down Key to scroll value .

Press Enter key to confirm the parameter value.

### 6. 3. Cancel Change of value



To cancel the changes before confirming, press Up key and Down Key simultaneously.



cancel the change

### 6. 4. Menu Exit



To exit from the setup menu or to return to the main menu from the sub menu, select the display screen with dot and press Enter Key.

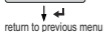

return to previous menu

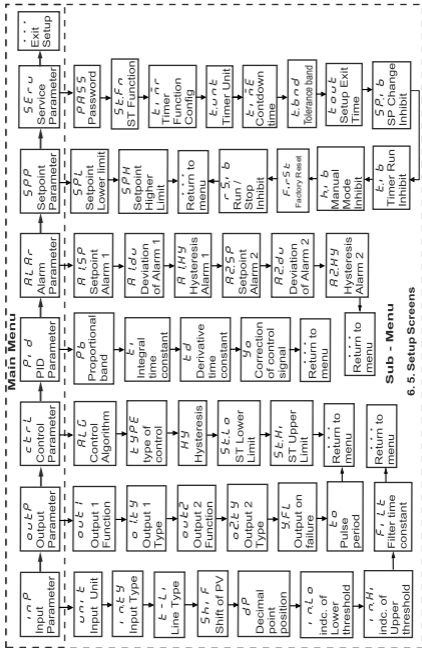

## 6. 6. Service Parameter

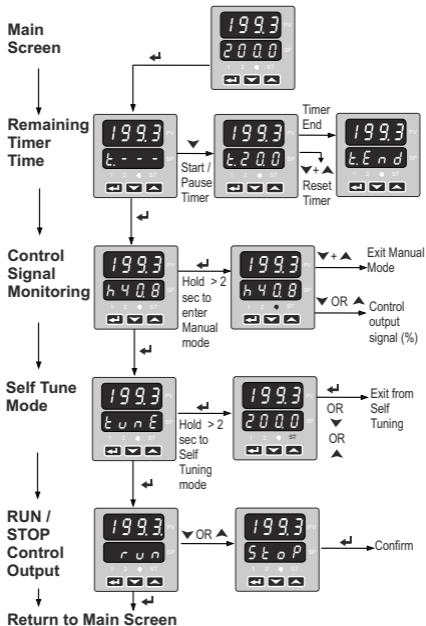

### **Remaining Timer Time**

Press Down Key to start timer or Pause timer.

When timer is pause, timer value start blinking.

Press Up key and Down key simultaneously to reset timer.

When timer countdown is finish, display shows t.End.

**Note: Set Timer inhibit function to disable, for accessing timer function.**

### **Control Signal Monitoring/ Manual Mode Entry**

This screen shows the output control signal in %.

Press & hold Enter key for approx 2 sec to enter into Manual control mode . In manual mode, hand symbol  starts blinking.

Use Up key or Down Key to set the output control signal(%).

Press Up Key & Down key simultaneously to exit from manual mode control.

**Note: Set Manual mode inhibit function to disable to start timer .**

### **Self tune (Auto tune) Mode**

Press & hold Enter key for approx 2 sec to enter into self tuning mode. In self tuning mode ST symbol will start blinking.

Pressing any key during self tuning will exit tune mode with showing error message on display.

**Note: Set ST inhibit function to disable, for accessing timer function.**

### **RUN/ST OP Control Output**

Press Up key or Down Key to change control output state. Press Enter key for confirmation.

**Note: Set Run/ Stop inhibit function to disable, for accessing RUN/ STOP function .**

## 6.7 Setup Parameters

**Table 1.Setup Parameters**

Symbol	Parameter description	Default setting	Range	
			Sensors	Linear input
<b>inp -- Input parameter</b>				
unit	Unit	°C	°C: Degree Celsius °F: Degree Fahrenheit PU: physical units	PU: physical units
inty	Type of main input	pt1	pt1: Pt100 pt10: Pt1000 t-j: thermocouple of J type t-t thermocouple of T type t-k: thermocouple of K type t-s: thermocouple of S type t-r: thermocouple of R type t-b: thermocouple of B type t-e: thermocouple of N type t-n: thermocouple of E type 0-20: linear current 0-20mA 4-20: linear current 4-20mA 0-5: linear voltage 0-5 V 0-10: linear voltage 0-10 V	
t-Li	Line type for the sensor Pt100	2-p	2-p: 2-wire 3-p: 3-wire	
sHif	measured value shift of the main input	0.0 °C	-100.0...100.0 °C (-180.0...180.0 °F)	-999...999
dp	Position of the main input decimal point	1-dp	0_dp: without decimal point 1_dp: 1 decimal place	0_dp: without decimal point 1_dp: 1 decimal place 2_dp: 2 decimal place
iNlo	Indication for lower threshold of the linear input	0	-	-1999...9999
iNHi	Indication for upper threshold of linear input	100.0	-	-1999...9999
filt	Time constant of the filter	0.0	0...999.9 (0 = OFF)	

Symbol	Parameter description	Default Setting	Range	
			Sensors	Linear input
<b>outp – Output parameters</b>				
out1	Function of output 1	y	off: without function y: control signal A.Hi : absolute upper alarm A.lo: absolute lower alarm du.Hi: relative upper alarm du.lo relative : lower alarm du.in: inner relative alarm du.ou: outer relative alarm aLtr: timer alarm rmot: remote operation	
o1ty	Output type 1*	rely	rely: relay output ssr: voltage output 0/5 V	
out2	Function of output 2	AHi	off: without function y: control signal A.Hi : absolute upper alarm A.lo: absolute lower alarm du.Hi: relative upper alarm du.lo relative : lower alarm du.in: inner relative alarm du.ou: outer relative alarm aLtr: timer alarm rmot: remote operation	
o2ty	Output type 2*	rely	none : no output rely: relay output ssr: voltage output 0/5 V	
Y.FL	Output on Failure	0.0	0...100.0 %	
to	Pulse period of output	20.0 s	0.5...99.9 s	

**Note: \* Parameter is not configurable & it is as per order code.**



Symbol	Parameter description	Default Setting	Range	
			Sensors	Linear input
<b>ctrl – Control parameters</b>				
alg	Control algorithm	pid	on.of : control algorithm on-off pid: control algorithm PID	
type	Kind of control	inu	dir: direct control (cooling) inu: reverse control(heating)	
Hy	Hysteresis	2.0 °C	0.2...100.0°C (0.2...180.0 °F)	2 ... 999
StLo	Lower threshold for Self tuning (Auto tuning)	0.0 °C	Parameters depended on the measuring range	
StHi	Upper threshold for Self tuning (Auto tuning)	800.0 °C	Parameters depended on the measuring range	
<b>pid – PID parameters</b>				
Pb	Proportional band	32.4 °C	0.1...550.0 °C (0.1...990.0 °F)	
ti	Integration time constant	820 s	0...9999 s	
td	Differentiation time constant	205.0 s	0.0...2500 s	
Yo	Correction of the control signal, for P or PD control type	0	0...100.0 %	

Symbol	Parameter description	Default Setting	Range	
			Sensors	Linear input
<b>alar – Alarm parameters</b>				
a1sp	Set point value for absolute alarm 1	100 °C	Parameters depended on the measuring range	
a1du	Deviation from the set point value for relative alarm 1	0.0 °C	-200.0...200.0°C (-360.0...360.0°F)	-1999 ... 1999
a1Hy	Hysteresis for alarm 1	10.0 °C	0.2...100.0°C (0.2...180.0 °F)	2 ... 999
a2sp	Set point value for absolute alarm 2	0.0 °C	Parameters depended on the measuring range	
a2du	Deviation from the set pointvalue for relative alarm 2	0.0 °C	-200.0...200.0°C (-360.0...360.0°F)	-1999 ... 1999
a2Hy	Hysteresis for alarm 2	2.0 °C	0.2...100.0°C (0.2...180.0 °F)	2 ... 999
<b>spp – Set point parameters</b>				
spl	Lower limitation of the fastset point value change	-200.0 °C (-328.0°F)	Parameters depended on the measuring range	
spH	Upper limitation of the fastset point value change	1767.0 °C (3212.6 °F)	Parameters depended on the measuring range	

Symbol	Parameter description	Default Setting	Range	
			Sensors	Linear input
<b>seru – Service parameters</b>				
PASS	Access code to the menu	0	0...9999 ( 0 = unlock i.e setup is not secure)	
StFn	Self-tuning function (Auto-tuning)	on	off: locked on: available	
timr	timer function Configuration	off	off: Timer function disable none: None stop: control stop tune: Start self tuning St.CL: Stop self tuning Hand: Switching into manual working	
t.unt	Timer value setting unit	min	min: Minute hour: Hour	
time	Counting off the time by the timer	30.0	0.1...999.9	
t.bnd	Tolerance band	10.0	0 ... 999.9 (0 = Function is OFF)	
tout	Automatic setup exit time	30 s	0...250 s	
SP.ib	Setpoint Inhibit	off	off : disable on : enable	
t.ib	Timer Inhibit	off	off : disable on : enable	
h.ib	Manual Control Inhibit	off	off : disable on : enable	
rS.ib	Control Output Run/Stop Inhibit	off	off : disable on : enable	
F.rST	Factory reset	no	no: no change in existing setting °C: Factory reset values in Celsius degrees °F: Factory reset values in Fahrenheit degrees PU: Factory reset values in physical units	

**Table 2. Parameter depending on Measuring range**

Symbol	Input / Sensor	Min	Max
pt1	Resistance thermometer Pt100	-200 °C (-328 °F)	850 °C (1562 °F)
pt10	Resistance thermometer Pt1000	-200 °C (-328 °F)	850 °C (1562 °F)
t-J	Thermocouple of J type	-100 °C (-148 °F)	1200 °C (2192 °F)
t-t	Thermocouple of T type	-100 °C (-148 °F)	400 °C (752 °F)
t-k	Thermocouple of K type	-100 °C (-148 °F)	1372 °C (2501,6 °F)
t-S	Thermocouple of S type	0 °C (32 °F)	1767 °C (3212,6 °F)
t-r	Thermocouple of R type	0 °C (32 °F)	1767 °C (3212,6 °F)
t-b	Thermocouple of B type	0 °C (32 °F)	1767 °C (3212,6 °F)
t-E	Thermocouple of E type	-100 °C (-148 °F)	1000 °C (1832 °F)
t-n	Thermocouple of N type	-100 °C (-148 °F)	1300 °C (2372 °F)
0 - 20	Linear current 0-20mA	-1999 <sup>1</sup>	9999 <sup>1</sup>
4 - 20	Linear current 4-20 mA	-1999 <sup>1</sup>	9999 <sup>1</sup>
0 - 5	Linear voltage 0-5 V	-1999 <sup>1</sup>	9999 <sup>1</sup>
0 - 10	Linear voltage 0-10 V	-1999 <sup>1</sup>	9999 <sup>1</sup>

**Note<sup>1</sup> : Parameter value depends on dp (decimal point), in.Lo and in.Hi value.**

## **7. Controller Input and Output**

### **7.1 Measuring Input**

Controller has programmable universal input, so different types of sensors or standard linear input can be connected. Set input type (in.ty) parameter to select type of input connected. Control output and Alarm output is dependent on input.

The display range for input is dependent on the selected input type and decimal point set. For Linear input, set lower threshold ( in.Lo) and Higher threshold(in.Hi) parameter.Set shift parameter ( Shif ) for

## 7.2 Outputs

The controller has two outputs. Both outputs can be configured as an alarm output. Any one output can be configured as control output.

For the proportional control the pulse period is additionally set.

The pulse period is the time which goes by between successive switches of the output during the proportional control. The length of the pulse period must be chosen depending on dynamic object properties and suitably for the output device. For fast processes, it is recommended to use SSR relays. The relay output is used to steer contactors in slow-changing processes.

The application of a high pulse period to steer slow changing processes can give unwanted effects in the shape of oscillations. In theory, lower the pulse period, better the control, but for a relay output it can be as large as possible in order to prolong the relay life.

Recommended setting for the pulse period:

Output Type	Pulse Period (t0)	Load
Relay	> 20 sec	2A / 230 VAC
	min 5 sec	1A / 230 VAC
Transistor Output	1 ... 3 sec	SSR Relay

## 8. Control Algorithm

Controller has two types of algorithm ON-OFF algorithm and PID algorithm.

### 8.1 ON-OFF Algorithm

When a high accuracy of temperature control is not required, especially for objects with a great time constant and small delay, one can apply the on-off control with hysteresis.

Advantages of this way of control are simplicity and liability, but disadvantage are the occurring oscillations, even at small hysteresis values.

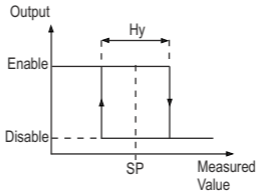

**Fig 1. Heating Output Type Operation**

## 8.2 PID Algorithm

When a high accuracy of the temperature control is required, use the PID algorithm.

PID parameters can be tuned manually as per requirement or automatically with use of auto tuning function.

### 8.2.1 Self Tuning (Auto Tuning)

This function is used to tune the PID parameter automatically as per object. In most of the case it provides optimum control.

To begin the Self Tuning, go to tune message screen and hold Enter key at least 2 seconds. If the control algorithm is set on on-off or the Self-tuning function is locked then, the tune message will be hidden.

For correct realization of the Self-tuning function, it is required to set St.lo and St.Hi parameters. The St.lo parameter must be set on the value corresponding to the measured value at disabled control. For temperature control objects, one can set 0°C. One must set the St.Hii parameter on the value corresponding to the maximum measured value at switched on control on full power.

In Self tuning mode, ST symbol will start blinking. The duration of auto-tuning depends on dynamic object properties and can last maximally

10 hours. In the middle of the Self-tuning or directly after it, over-regulations can occur, and for this reason one must set a smaller set point, if it possible.

The Self-tuning process will be stopped without counting PID settings, if a supply decay occurs or the Enter key is pressed. In this case, the control with current PID settings begins.

If the Self-tuning is not achieved with success, the error code will be displayed refer the table 3 .

**Table 3. Self Tuning (Auto Tuning) Error Codes**

<b>Error code</b>	<b>Reason</b>	<b>Corrective Action</b>
ES.01	P and PD control was selected	For auto tuning, PI or PID control is required . Ti parameter must be greater than zero.
ES.02	Setpoint value is incorrect	Change Setpoint value or St.lo & St.Hi settings
ES.03	auto tuning interrupted due to 1.Enter key was pressed. 2.Control Run/Stop function 3.Timer setting	Control Run/Stop function should be set to run.Check the timer function settings.
ES.04	The maximal duration time of auto-tuning was exceeded.	Check if the temperature sensor is correctly placed and if the set point value is not set too higher for the given object.
ES.05	The waiting time for switching was exceeded	
ES.06	The measuring input range was exceeded.	Check sensor connections. Do not allow that an over-regulation could cause the exceeding of the input measuring range.
ES.20	Very non-linear object, making impossible to obtain correct PID parameter values, or noises have occurred.	Carry out the auto-tuning again. If that does not help, select manually PID parameters.

### 8.2.2 Tuning of PID parameter in case of a dissatisfying control

The best way to select PID parameters is to change the value a twice higher or a twice lower. During changes, one must respect following principles:

**Table 4. Tuning PID Parameter**    ↑ - Increase ↓ - Decrease

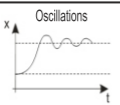
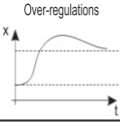
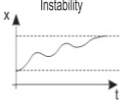
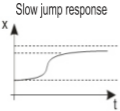
Controlled Quantity	P	PD	PI	PID
Oscillations 	Pb ↑	Pb ↑ td ↓	Pb ↑ ti ↑	Pb ↑ ti ↑ td ↓
Over-regulations 	Pb ↑	Pb ↑ td ↑	Pb ↑ ti ↑	Pb ↑ ti ↑ td ↑
Instability 		Pb ↓ td ↓		Pb ↓ td ↓
Slow jump response 	Pb ↓	Pb ↓	ti ↓	Pb ↓ ti ↓



## 9. Alarms

Controller provides seven alarm types one of which can be assigned to any output. The alarm configuration requires the selection of the alarm type through setting out 1, out 2 parameters on the suitable type of alarm. Available types of alarms are given on following figure.

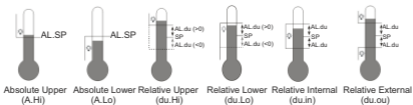

**Fig 2. Types of alarms**

The set point value for absolute alarms is the value defined by the Ax.SP parameter.

For relative alarms, it is the deviation from the set point value in the main channel - Ax.du parameter.

The alarm hysteresis, i.e. the zone around the set point value, in which the output state is not changed, is defined by the Ax.Hy parameter.

## 10. Timer Function

When reaching the set point temperature (SP) the timer begins the countdown of the time defined by the time parameter. After counting down to zero, the timer alarm is set, which remains active till the moment of the timer erasing.

To activate the timer function, one must set the parameter *timr*.

To indicate the alarm state on an output, one of the outputs out1, out2 should be set to AL.tr.

The timer status/ residual time is displayed with the mark "t" on the first position. To display it, one must press the Enter key till the moment of its appearance on the lower display (acc. to the fig.3)

The return to the set point value display is set by the manufacturer on 30 sec, but can be changed.

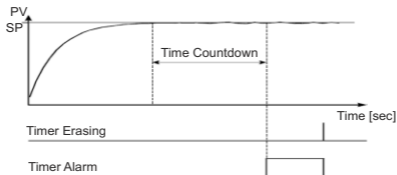
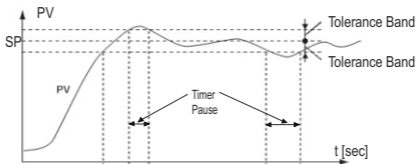

**Fig 3. Principle of timer operation**

Status	Description	Signaling
Timer stopped		t - - -
Starting of the timer	- Temperature over SP - Press the Down key	Residual time in minutes : e.g. ( t 2 9 . 9 )
Pause of the timer	Press the Down key	Flickering residual time in minutes
End of the countdown	Reaching zero by the timer	t E n d
Timer erasing	During the countdown : Press Down key and Up key	
	After the countdown end : - Press the Up key - Through the binary input	

### 10.1 Tolerance band (t.bnd)

This is the band around the set-point in which timer starts running automatically when the process value has reached a tolerance band . When Tolerance band is enable the timer starts only if process value is in tolerance band. When process value is jump outside the tolerance band, timer will pause & it automatically starts running when the process value is come within the tolerance band. If the Tolerance band is set to zero, this function is disabled.



**Fig 4. Timer operation with Tolerance Band**

## 10.2 Timer Functions(timr)

Timer Output can be assigned to following soft function to take action when the timer countdown is completed.

1. **Off** Timer Function is disable.
2. **None**: Timer Function is enable but the output of timer is not assigned to any of the soft features.
3. **Stop**: Control output is stopped when the timer countdown is completed.(only when one of the output is control)
4. **Tune**: Start the auto tuning when the timer countdown is completed.(only when one of the output is PID control & auto tuning function is enable & control output is set to RUN)
5. **St.CL**: Cancel auto tuning when the timer countdown is completed.(only when one of the output is PID control & the meter is in the auto tuning mode & control output is set to RUN)
6. **HAnd**: Jump to Manual mode when the timer countdown is completed.(only when one of the output is control )

## 11. ADDITIONAL FUNCTIONS

### 11.1 Control Signal Monitoring

The control signal is displayed with the mark "h" on the first position. The accessibility of the control signal depends on the suitable controller configuration. To display the control signal, one must press the Enter key till the moment of its appearance on the lower display. The return to the set point value display is set by the manufacturer on 30 sec. but it can be changed.

## 11.2 Manual Control

The input to the manual control mode follows after holding down the Enter key during the control signal monitor screen display. The manual control is signaled by blinking of  $\Phi$  symbol. The controller interrupts the automatic control and begins the manual control of the output. The control signal value is on the lower display, preceded by the symbol "h - " for the main channel.

Down key and Up key serve to change the control signal. The exit to the normal working mode follows after the simultaneous pressure of Down key and Up key.

At set on-off control on the output 1 (parameter PB=0), one can set the control signal on 0% or 100% of the power, however when the PB parameter is higher than zero, one can set the control signal on any value from the range 0...100%.

## 11.3 Digital Filter

In case when the measured value is unstable, one can switch a programmed low-pass filter on. One must set the lowest possible time constant at which the measured value is stable. A high time constant can cause control instability. The time constant of the filter (Filt) can be set from 0.0 sec. up to 999 seconds.

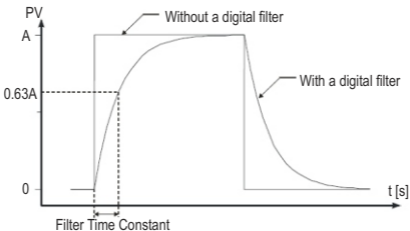

**Fig 5. Time characteristic of the filter**

## 12. Factory Reset Function

**Table 5 . Factory Reset Values**

Parameter symbol	Parameter description	Factory Reset setting (°C)	Factory Reset setting (°F)	Factory Reset setting (PU)
<b>inP -- input parameter</b>				
unit	Unit	°C	°F	PU
inty	Type of input	pt1	pt1	pt1
t-Li	Line type (PT100)	2-p	2-p	2-p
sHif	shift	0.0 °C	0.0 °F	0.0
dp	Position of decimal point	1-dp	1-dp	1-dp
iNlo	Indication for the lower threshold of the linear input	NA	NA	0.0
iNHi	Indication for the upper threshold of the linear input	NA	NA	100
filt	Time constant of the filter	0.0	0.0	0.0
<b>outp – Output parameters</b>				
out1	Function of output 1	y	y	y
o1.ty	Output type 1*	rely	rely	rely
out2	Function of output 2	Ahi	AHi	AHi
o2ty	Output type 2*	rely	rely	rely
Y.FL	output on failure	0	0	0
to	Pulse period	20.0 s	20.0 s	20.0 s



Parameter symbol	Parameter description	Factory Reset setting (°C)	Factory Reset setting (°F)	Factory Reset setting (PU)
<b>ctrl – Control parameters</b>				
alg	Control algorithm	pid	pid	pid
type	Kind of control	inu	inu	inu
Hy	Hysteresis	2.0 °C	3.6 °F	3.6
StLo	Lower threshold for auto tuning	0.0 °C	32.0 °F	0.0
StHi	Upper threshold for auto tuning	800.0 °C	1472°F	999.9
<b>pid – PID parameters</b>				
Pb	Proportional band	32.4 °C	54°F	54
ti	Integration time constant	820 s	820 s	820 s
td	Differentiation time constant	205.0 s	205.0 s	205.0 s
yo	Correction of the control signal	0	0	0
<b>alar –Alarm parameters</b>				
a1sp	Set point value for absolute alarm 1	100 °C	212°F	212
a1du	Deviation from the set pointvalue for relative alarm 1	0.0 °C	0.0 °F	0.0

Parameter symbol	Parameter description	Factory Reset setting (°C)	Factory Reset setting (°F)	Factory Reset setting (PU)
a1Hy	Hysteresis for alarm 1	10.0 °C	50.0 °F	50
a2sp	Set point value for absolute alarm 2	0.0 °C	32.0 °F	32
a2du 3	Deviation from the set point value for relative alarm 2	0.0 °C	0.0°F	0
a2Hy	Hysteresis for alarm 2	2.0 °C	3.6 °F	50
<b>SPP – Set point parameters</b>				
spl	Lower limitation of the fastset point value change	-200 °C	-328 °F	-199.9
spH	Upper limitation of the fastset point value change	1,767°C	3213 °F	999.9
<b>seru – Service parameters</b>				
PASS	Access code to the menu	0	0	0
StFn	Auto-tuning function	on	on	on
timr	timer function after countdown completion	off	off	off
t.unt	Timer value setting unit either minute or hour	min	min	min
time	Counting off the time by the timer	30	30	30
t.bnd	Tolerance band	10	10	10

Parameter symbol	Parameter description	Factory Reset setting (°C)	Factory Reset setting (°F)	Factory Reset setting (PU)
tout	Automatic setup exit	30 s	30 s	30 s
F.rST	Factory reset	no	no	no
rsib	Run start inhibit	off	off	off
SP.ib	Set point inhibit	off	off	off
t.ib	Timer inhibit	off	off	off
h.ib	Manual mode inhibit	off	off	off

Note \* Parameter as per order

**Table 6 . Error Signaling**

Error Code	Reason	Procedure
	Down overflow of the range limit or lack of RTD	Check, if input signal values are situated in the appropriate range – if yes, check if there is no short circuit in the thermoresistor or the thermocouple is connected
	Upper overflow of the range limit or break in the sensor circuit	Check, if input signal values are situated in the appropriate range – if yes, check if there is no break in the sensor circuit.



**Table 7 . Controller Error**

Error Code	Reason	Procedure
$E_{rAd}$	Input discalibrated	Connect the controller supply again and if that is not effective, contact the nearest service shop.
$E_{rEE}$	Configuration parameters checksum error	

### 13. Technical Data

#### Input signals

Input Type	Ranges	
Pt100	-200 .. 850 °C	-328 .. 1562 °F
Pt1000	-200 .. 850 °C	-328 .. 1562 °F
Fe-CuNi (J)	-100 .. 1200 °C	-148 .. 2192 °F
Cu-CuNi (T)	-100 .. 400 °C	-148 .. 752 °F
NiCr-NiAl (K)	-100 .. 1372 °C	-148 .. 2501.6 °F
PtRh10-Pt (S)	0 .. 1767 °C	32 .. 3212.6 °F
PtRh13-Pt (R)	0 .. 1767 °C	32 .. 3212.6 °F
PtRh30-PtRh6 (B)	0 .. 1767 °C <sup>1)</sup>	32 .. 3212.6 °F <sup>1)</sup>
NiCrSi-NiSi (N)	-100 .. 1300 °C	-148 .. 2372 °F
NiCr-CuNi (E)	-100 .. 1000 °C	-148 .. 1832 °F
Current Channels (I)	0 / 4 .. 20 mA	
Voltage Channels (V)	0 .. 5 / 10 V	

**Note:** <sup>1)</sup> Intrinsic error is related to measuring range: 200 ... 1767 °C (392 ... 3212.6 °F)

<b>Measurement time</b>	0.2 sec
<b>Current flowing through RTD</b>	0.128 mA
<b>Input Resistance</b>	
- Voltage Input	> 450 k $\Omega$
- Current Input	< 18 $\Omega$
<b>Input Error Detection</b>	
- RTD, Thermocouple	Outside Range
- 0 - 10 V	> 11V
- 0 - 5 V	> 5.5 V
- 0 - 20 mA	> 22 mA
- 4 - 20 mA	< 1 mA and > 22 mA
<b>Auxiliary Supply</b>	
- Higher Aux	60 V - 280 V AC/DC
- Higher Aux supply frequency	45 to 65 Hz range
- Higher Aux Nominal Value	230 V AC/DC 50/60 Hz for AC
Aux	OR
- Lower Aux	20 V - 60 VDC / 20 V - 40 VAC
- Lower Aux supply frequency	45 to 65 Hz range
- Lower Aux Nominal Value	48 V DC / 24 V AC 50/60 Hz for AC Aux
<b>VA Burden</b>	
- Auxiliary Supply Burden :	< 6 VA
<b>Types of Outputs :</b>	
- Relay Contact	SPST-NO, rated load: 5A/230V
- SSR Drive Output	5 V, maximum load capacity: 40mA
<b>Accuracy :</b>	
- RTD	0.3 % of range
- Thermocouple	0.3 % of range (0.5 % of range for B, R, S)
- Analog Input	0.2 % of range $\pm$ 2 digit
- Additional Errors	$\leq$ 2 $^{\circ}$ C (Cold Junction Compensation Temperature Change for thermocouple)

---

**Reference Conditions for Accuracy :**

---

- Ambient Temperature	23 °C
- Pre-conditioning	20 min

---

**Influence of Variations :**

---

## Temperature Coefficient

- RTD	0.025 % / Deg
- Thermocouple	0.025 % / Deg
- Current	0.025 % / Deg
- Voltage	0.05 % / Deg

---

**Applicable Standards :**

---

- EMC	IEC 61326 - 1 : 2012*
- Safety	IEC 61010- 1- 2010, Permanently Connected Use
- IP for water and dust	IEC 60529
- Pollution degree	2
- Installation Category	II

---

**Isolation :**

---

- Protective Class	2
High Voltage Test	
- Input+Output +Aux Vs Surface	2.2 kV RMS, 50Hz, 1min
- Input+SSR Output Vs Relay Output	2.2 kV RMS, 50Hz, 1min
- Aux Vs Remaining circuit	2.2 kV RMS, 50Hz, 1min

---

**Installation Data**

---

## A) RE 57

Bezel size	48 mm X 48 mm (DIN 43718)
Panel Cutout	45+0.6mm X 45+0.6mm
Weight	Approx. 0.3 Kg

## B) RE 77

Bezel size	48 mm X 96 mm (DIN 43718)
Panel Cutout	45+0.6mm X 92+0.6mm
Weight	Approx. 0.35 Kg

CJ RE 96

Bezel size

96 mm X 96 mm (DIN 43718)

Panel Cutout

92+0.6mm X 92+0.6mm

Weight

Approx. 0.6 Kg

### Environmental :

- |                                   |   |
|-----------------------------------|---|
| - Operating Temperature           | -20 °C to +70 °C  |
| - Storage Temperature             | -30 °C to +80 °C  |
| - Relative Humidity               | 0 ... 90 %RH (non condensing)   |
| - Warm up time                    | 30 min  |
| - Shock<br>(As per IEC60068-2-27) | Half sine wave, Peak acceleration<br>30g <sub>n</sub> (300 m/s <sup>2</sup> ),duration 18ms |
| - Vibration                       | 10 ...150 ...10 Hz, 0.15 mm<br>amplitude  |
| - No. of sweep cycles             | 10 per axis   |
| - Enclosure                       | IP 54 (front face),<br>IP 20 (terminal side)  |
| -Altitude                         | 2000 m max  |
| - Location                        | Indoor Use  |

\*Note:- The instrument continues to operate at a measuring accuracy of within  $\pm 2\%$  of the range during test.

### Meaningf Symbols



Warning concerning a point of danger  
(Attention: Observed Documentation)



AC / DC voltage

## Note

---

**Sifam Tinsley Instrumentation Inc.**

3105 Creekside Village Drive, Suite No. 801, Kennesaw, GA 30144 (USA)

Contact No. : +1 404 736 4903

E-mail Id : [psk@sifamtinsley.com](mailto:psk@sifamtinsley.com)

Web : [www.sifamtinsley.com](http://www.sifamtinsley.com)

---